

TWO STAGE DUAL FUEL BURNERS

▶ **RLS SERIES**

▶ RLS 28	100/163 ÷ 325 kW
▶ RLS 38	116/232 ÷ 442 kW
▶ RLS 50	145/290 ÷ 581 kW
▶ RLS 70	232/465 ÷ 814 kW
▶ RLS 100	349/698 ÷ 1163 kW
▶ RLS 130	465/930 ÷ 1395 kW



The RLS series of burners covers a firing range from 163 to 1395 kW, and it has been designed for use in low or medium temperature hot water boilers, hot air or steam generators, diathermic oil boilers.

Operation is "two stage"; the burners are fitted with an electronic device STATUS PANEL, which supplies complete diagnostic functions: hour meter, ignition meter, identification of trouble shooting.

Optimisation of sound emissions is guaranteed by the use of fans with reverse curve blades and sound deadening material incorporated in the air suction circuit.

The elevated performance of the fans and combustion head guarantee flexibility of use and excellent working at all firing rates.

The exclusive design ensures reduced dimensions, simple use and maintenance. A wide range of accessories guarantees elevated working flexibility.

TECHNICAL DATA

Model		▼ RLS 28	▼ RLS 38	▼ RLS 50	▼ RLS 70	▼ RLS 100	▼ RLS 130	
Operation		Two stage						
Modulating ratio at max. output		2:1						
Servomotor	type	LKS 210 - 08			LKS 210 -10			
	run time	s						
Heat output	kW	100/163-325	116/232-442	145/290-581	232/465-814	349/698-1163	465/930-1395	
	Mcal/h	86/140-303	100/200-380	125/249-500	200/400-700	300/600-1000	400/800-1200	
Working temperature		°C min/max						
Light oil		°C						
Light oil	Net calorific value	kWh/kg						
	Viscosity at 20°C	mm ² /s (cSt)						
	Delivery	kg/h	8/14-28	10/20-37	12/25-49	20/39-69	30/59-99	39/79-118
	Max temperature	°C						
Pump	type	AL 65B			AJ 6CC			
	delivery	kg/h	63 (at 15 bar)			134 (at 20 bar)		
Atomised pressure		bar						
G20	Net calorific value	kWh/Nm ³						
	Density	kg/Nm ³						
	Delivery	Nm ³ /h	10/16-32,5	12/23-44	14,5/29-58	23/46,5-81	35/70-116	46,5/93-139,5
G25	Net calorific value	kWh/Nm ³						
	Density	kg/Nm ³						
	Delivery	Nm ³ /h	12/19-38	13/27-51	17/33-68	27/54-95	41/81-135	54/108-162
LPG	Net calorific value	kWh/Nm ³						
	Density	kg/Nm ³						
	Delivery	Nm ³ /h	4/6-13	4/9-17	6/11-23	9/18-32	14/27-45	18/36-54
Fan		type						
Air temperature		max °C						
Electrical supply		Ph / Hz / V			3N/50/230-400 (±10%)			
Auxiliary electrical supply		Ph / Hz / V						
Control box		type						
Total electrical power		kW	0,53	0,76	0,91	1,8	2,2	3
Auxiliary electrical power		kW	0,19	0,25	0,17	0,33	0,33	0,43
Protection level		IP						
Fan electrical motor power		kW	0,25	0,42	0,65	1,1	1,5	2,2
Rated fan motor current		A	2,1	2,9	3 -1,7	4,8 - 2,8	5,9 - 3,4	8,8 - 5,1
Fan motor start current		A	4,8	11	13,8-8	22,6 -13,2	29,5 -17	52,8 - 30,6
Fan motor protection level		IP						
Pump electric motor power		kW	0,09			0,37		
Rated pump motor current		A	0,8			2,4		
Pump motor start current		A	-	-	-	-	-	
Pump motor protection level		IP						
Ignition transformer		V1- V2						
		I1 - I2						
Working		Intermittent (at least one stop every 24h)						
Sound pressure		dBA	68	70	72	74	77,5	80
Sound power		W	-	-	-	-	-	-
Light oil	CO emissions	mg/kWh	< 20					
	Grade of smoke indicator	N° Bacharach	< 1					
	CxHy emissions	mg/kWh	< 10					
	NOx emissions	mg/kWh	< 190					
G20	CO emissions	mg/kWh	< 15					
	NOx emissions	mg/kWh	< 80					
Directive		90/396/EC - 89/336 (2004/108) EC - 73/23/EC - 92/42/EC						
Conforming to		EN 267 - EN 676						
Certifications		CE 0063 AR 4637			CE 0063 AS 4863 - DIN 5G 835/97 M			

Reference conditions:

Ambient temperature: 20°C

Pressure: 1000 mbar

Altitude: 100 m a.s.l.

Sound pressure level measured in manufacturers combustion laboratory, with burner operating on test boiler and at maximum rated output

Since the Company is constantly engaged in the production improvement, the aesthetic and dimensional features, the technical data, the equipment and the accessories can be changed.

This document contains confidential and proprietary information of RIELLO S.p.A. Unless authorised, this information shall not be divulged, nor duplicated in whole or in part.

FIRING RATES

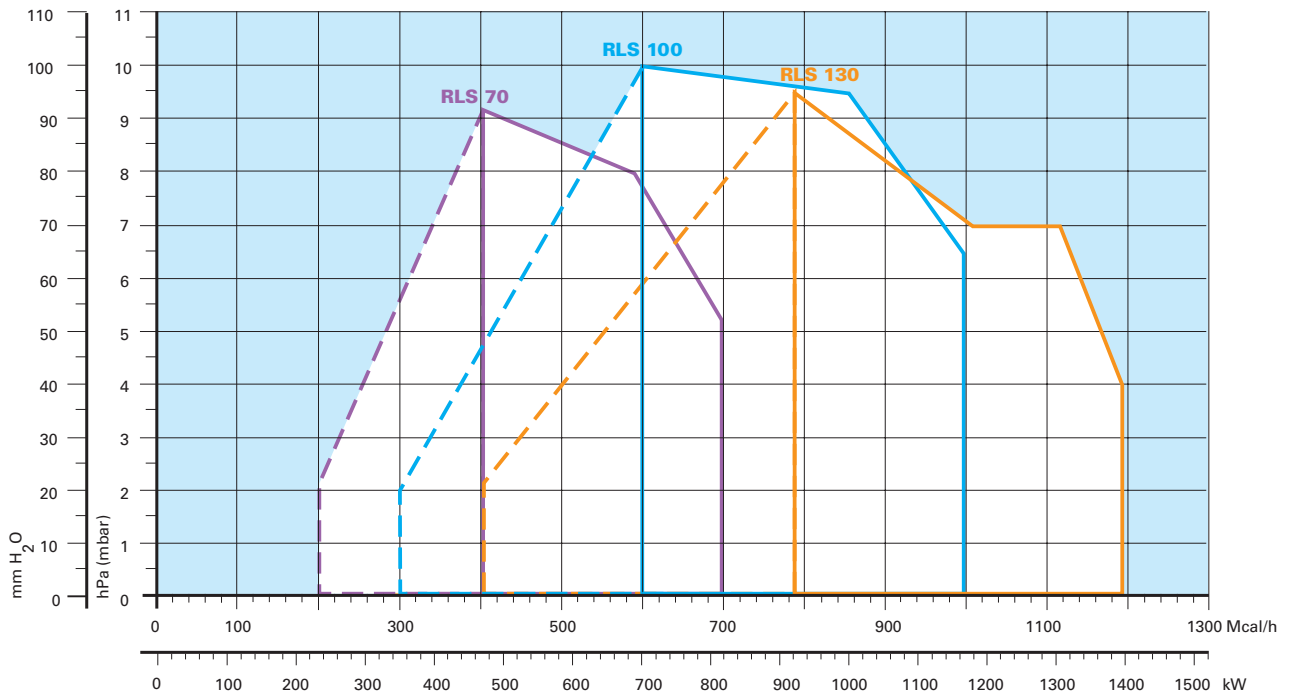
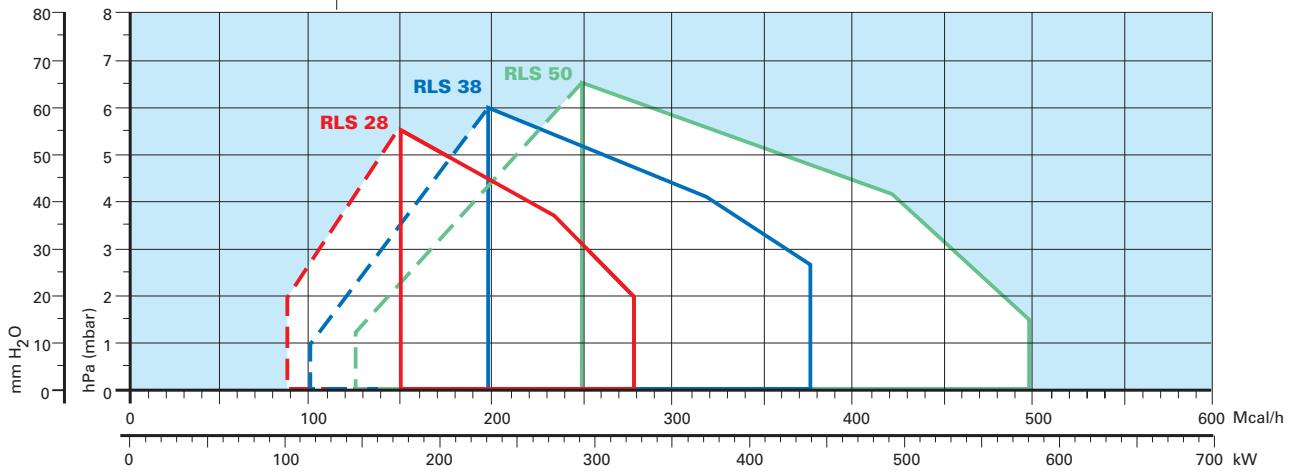

Useful working field for choosing the burner

Modulating range

Test conditions conforming to EN 267 - EN 676:

Temperature: 20°C
 Pressure: 1013.5 mbar
 Altitude: 100 m a.s.l.





FUEL SUPPLY

GASTRAIN

The gas trains are fitted with a regulating valve to adjust fuel delivery in relation to heat required. This valve is controlled by the two-stages device fitted on the burner.

Fuel can be supplied either from the right or left sides, on the basis of the application requirements. A maximum gas pressure switch stops the burner in case of excess of pressure in the supply line. The gas train can be selected to best fit system requirements depending on the fuel output and pressure in the supply line.

The gas trains can be "Multibloc" type (containing the main components in a single unit) or "Composed" type (assembly of the single components).

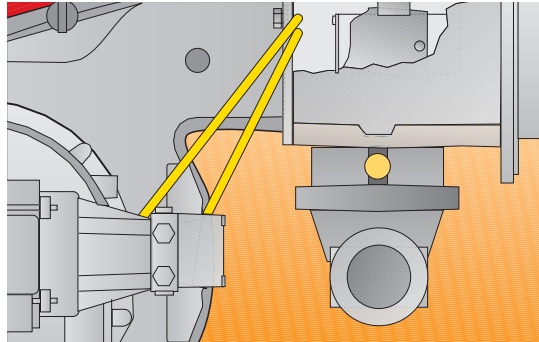

Example of gas inlet pipe burners for RLS 70-100-130

MULTIBLOC gas train without seal control

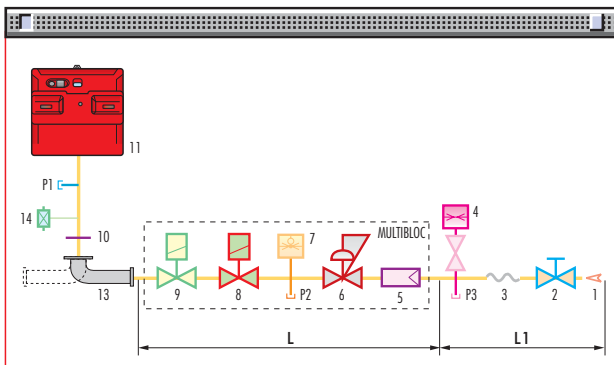

MULTIBLOC gas train with seal control

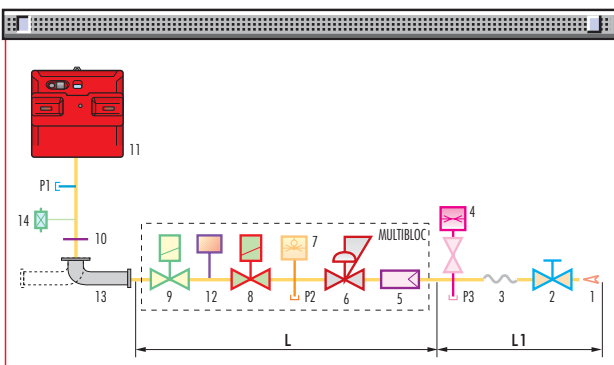

COMPOSED gas train without seal control

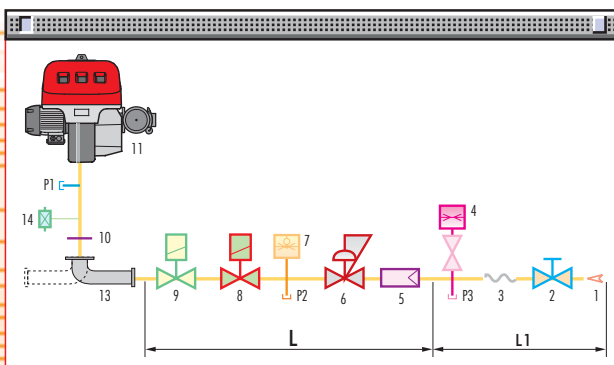

1	Gas input pipework
2	Manual valve
3	Anti-vibration joint
4	Pressure gauge with pushbutton cock
5	Filter
6	Pressure regulator (vertical)
7	Minimum gas pressure switch
8	VS safety solenoid (vertical)
9	VR regulation solenoid (vertical). Three adjustments: - ignition delivery (rapid opening) - 1 st stage delivery (slow opening) - 2 nd stage delivery ((slow opening)
10	Gasket and flange supplied with the burner
11	Burner
12	Seal control mechanism for valves 8-9. According to standard EN 676, the seal control is compulsory for burners with maximum output above 1200 kW
13	Gas train-burner adapter.
14	Maximum gas pressure switch
P1	Combustion head pressure
P2	Pressure downstream from the regulator
P3	Pressure upstream from the filter
L	Gas train supplied separately, with the code given in the table
L1	Installer's responsibility

COMPOSED gas train with seal control

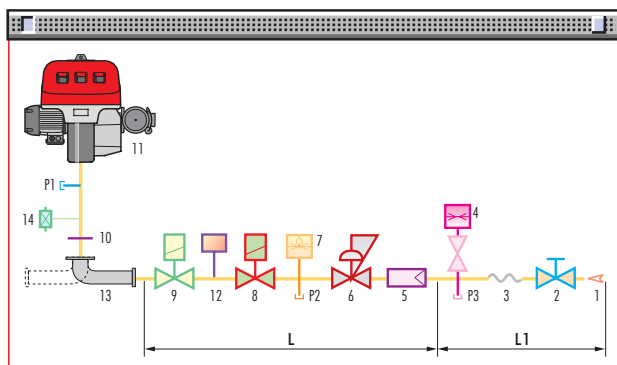

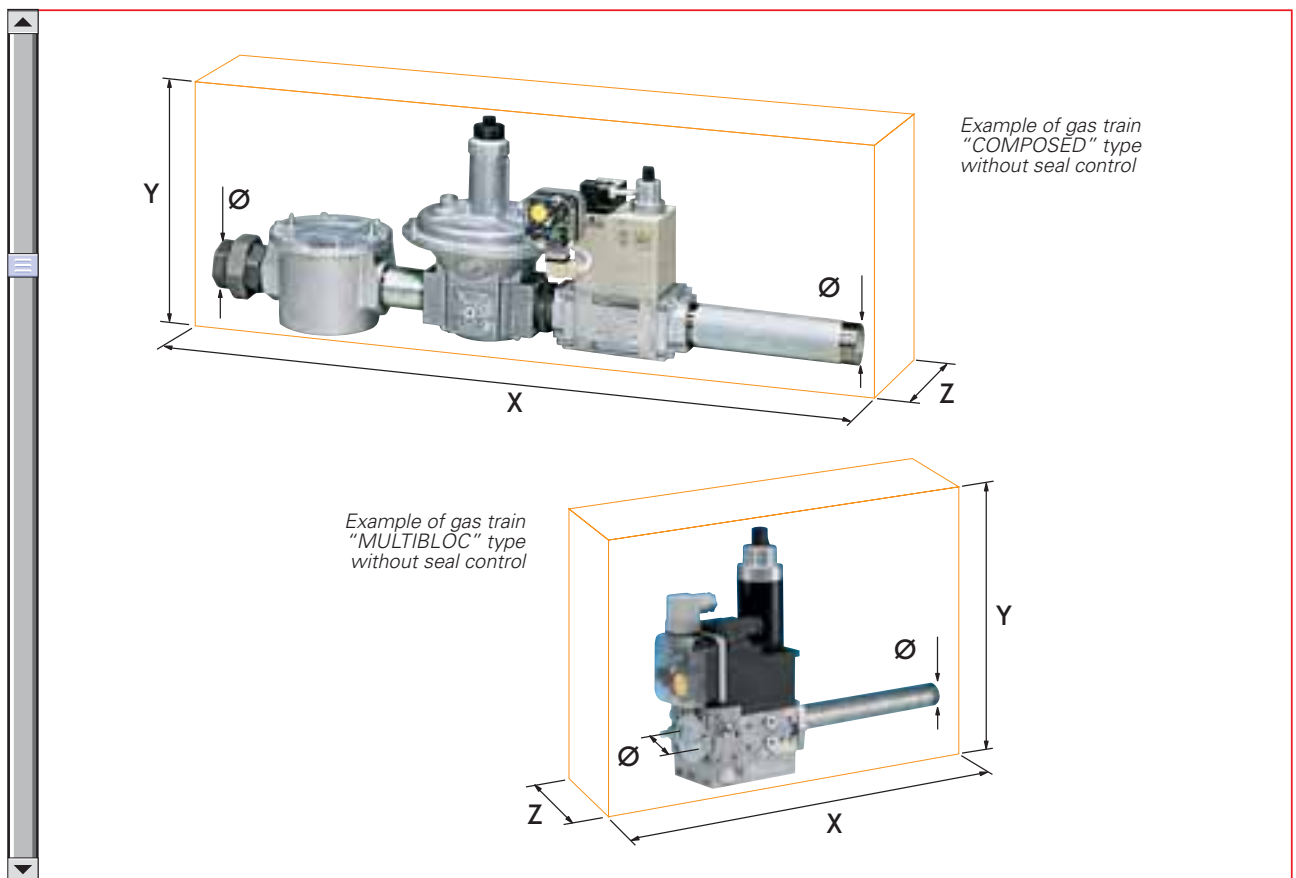

Gas trains are approved by standard EN 676 together with the burner.

The overall dimensions of the gas train depends on how they are constructed. The following table shows the maximum dimensions of the gas trains that can be fitted to RLS burners, intake and outlet diameters and seal control if fitted.

Please note that the seal control can be installed as an accessory, if not already installed on the gas train.

The maximum gas pressure of gas train "Multibloc" type is 300 mbar, and that one of gas train "Composed" type is 500 mbar.

	Name	Code	Ø i	Ø o	X mm	Y mm	Z mm	Seal Control
MULTIBLOC GAS TRAINS	MBZRDLE 407	3970046	3/4"	3/4"	195	235	120	-
	MBZRDLE 410	3970079	1"	3/4"	195	235	145	-
	MBZRDLE 412	3970152	1" 1/4	1" 1/2	433	290	145	-
	MBZRDLE 415	3970183	1" 1/2	1 21/2	523	346	100	-
	MBZRDLE 420	3970184	2"	2"	523	400	100	-
	MBZRDLE 420 CT	3970185	2"	2"	523	400	227	Incorporated
COMPOSED GAS TRAINS	CB 40/2	3970153	1" 1/2	1" 1/2	1013	346	195	-
	CB 50/2	3970154	2"	2"	1150	354	250	-
	CB 50/2 CT	3970166	2"	2"	1150	354	320	Incorporated
	CBF 65/2	3970155	DN 65	DN 65	1166	475	285	-
	CBF 65/2 CT	3970167	DN 65	DN 65	1166	475	285	Incorporated
	CBF 80/2	3970156	DN 80	DN 80	1246	425	285	-
CBF 80/2 CT	3970168	DN 80	DN 80	1246	425	285	incorporated	



► PRESSURE DROP DIAGRAMS

The diagrams indicate the minimum pressure drop of the burners with the various gas trains that can be matched with them; at the value of these pressure drop add the combustion chamber pressure.

The value thus calculated represents the minimum required input pressure to the gas train.

NATURAL GAS

LPG

RLS 28

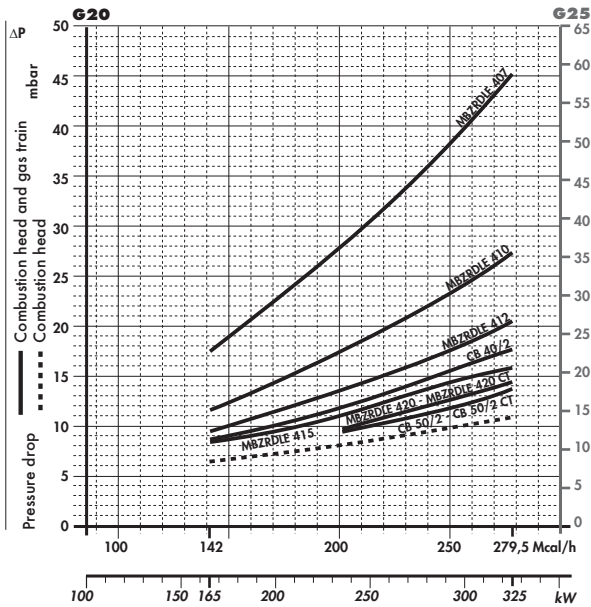

Gas train	Code	Adapter	Seal Control
MBZRDL 407	3970046	3000824	Accessory
MBZRDL 410	3970079	3000824	Accessory
MBZRDL 412	3970152	-	Accessory
MBZRDL 415	3970183	-	Accessory
CB 40/2	3970153	-	Accessory

RLS 28

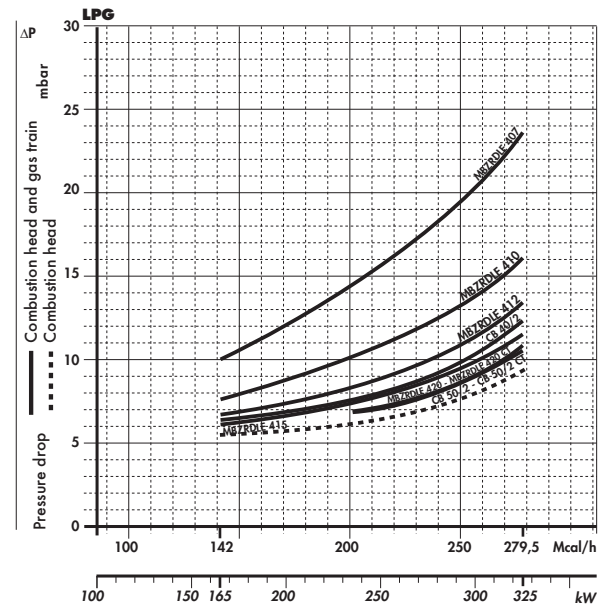

Gas train	Code	Adapter	Seal Control
MBZRDL 420	3970184	3000822	Accessory
MBZRDL 420 CT	3970185	3000822	Incorporated
CB 50/2	3970154	3000822	Accessory
CB 50/2 CT	3970166	3000822	Incorporated

RLS 38

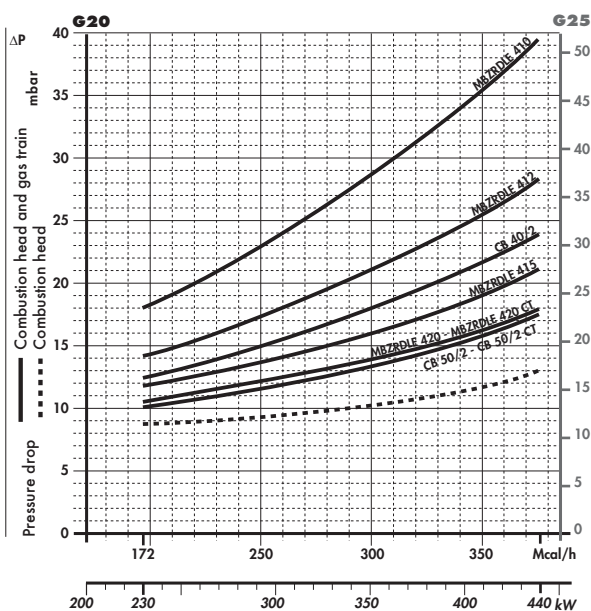

Gas train	Code	Adapter	Seal Control
MBZRDL 410	3970079	3000824	Accessory
MBZRDL 412	3970152	-	Accessory
MBZRDL 415	3970183	-	Accessory
CB 40/2	3970153	-	Accessory

RLS 38

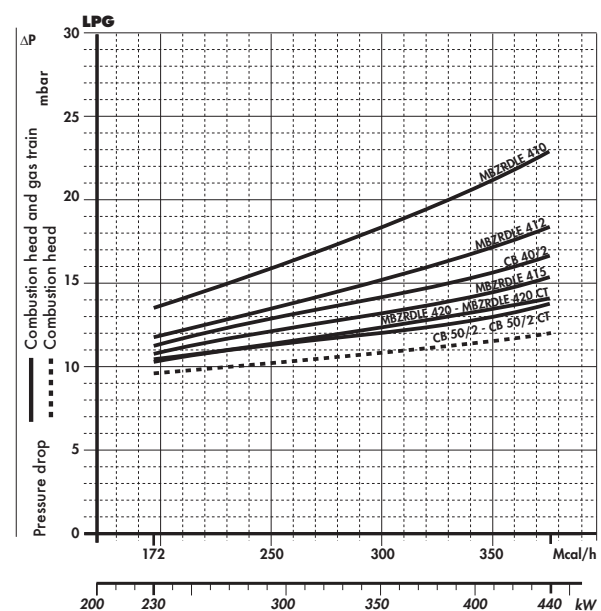

Gas train	Code	Adapter	Seal Control
MBZRDL 420	3970184	3000822	Accessory
MBZRDL 420 CT	3970185	3000822	Incorporated
CB 50/2	3970154	3000822	Accessory
CB 50/2 CT	3970166	3000822	Incorporated



NATURAL GAS

LPG

RLS 50

RLS 50

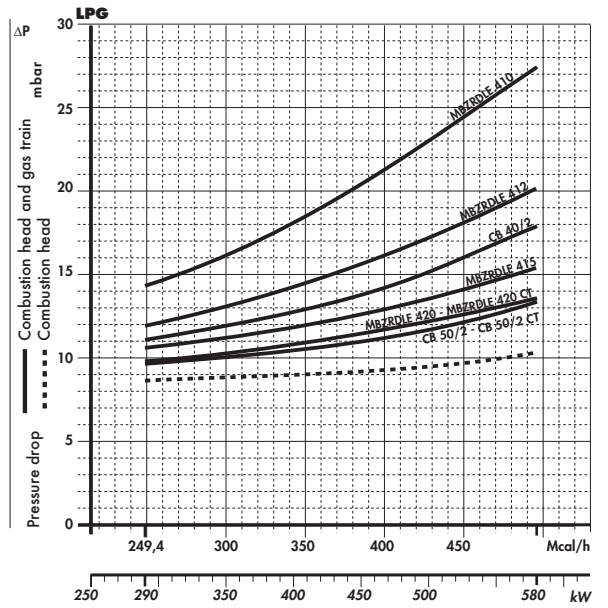
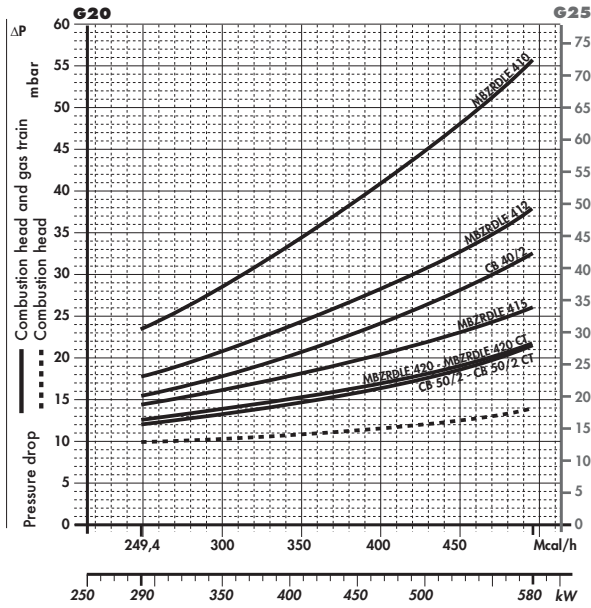

Gas train	Code	Adapter	Seal Control
MBZRDLE 410	3970079	3000824	Accessory
MBZRDLE 412	3970152	-	Accessory
MBZRDLE 415	3970183	-	Accessory
CB 40/2	3970153	-	Accessory

Gas train	Code	Adapter	Seal Control
MBZRDLE 420	3970184	3000822	Accessory
MBZRDLE 420 CT	3970185	3000822	Incorporated
CB 50/2	3970154	3000822	Accessory
CB 50/2 CT	3970166	3000822	Incorporated

RLS 70

RLS 70

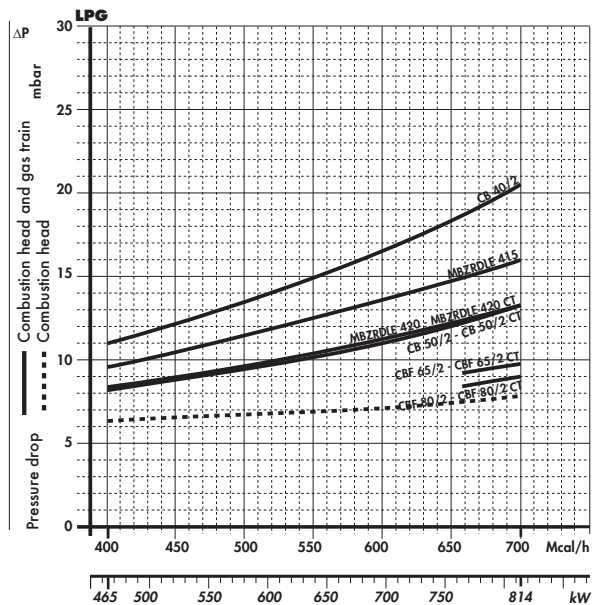
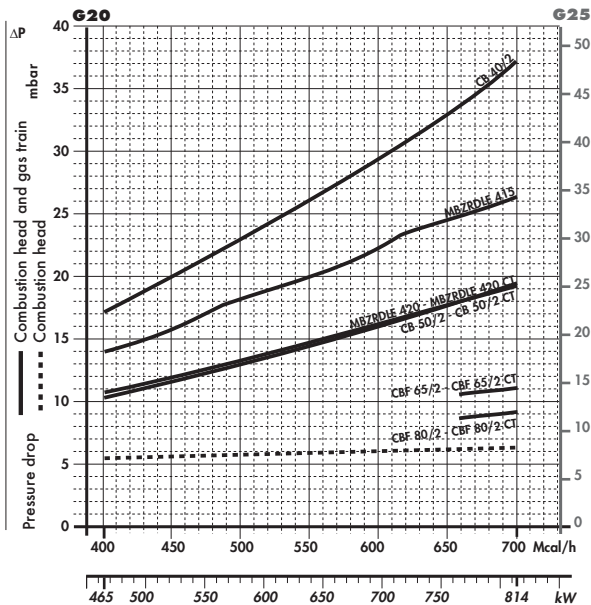

Gas train	Code	Adapter	Seal Control
MBZRDLE 415	3970183	3000843	Accessory
CB 40/2	3970153	3000843	Accessory
MBZRDLE 420	3970184	-	Accessory
MBZRDLE 420 CT	3970185	-	Incorporated
CB 50/2	3970154	-	Accessory

Gas train	Code	Adapter	Seal Control
CB 50/2 CT	3970166	-	Incorporated
CBF 65/2	3970155	3000825	Accessory
CBF 65/2 CT	3970167	3000825	Incorporated
CBF 80/2	3970156	3000826	Accessory
CBF 80/2 CT	3970168	3000826	Incorporated



NATURAL GAS

LPG

RLS 100

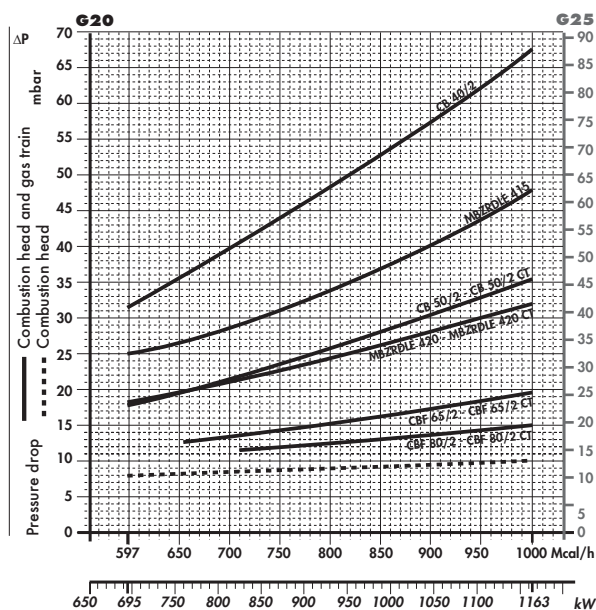

Gas train	Code	Adapter	Seal Control
MBZRDLE 415	3970183	3000843	Accessory
CB 40/2	3970153	3000843	Accessory
MBZRDLE 420	3970184	-	Accessory
MBZRDLE 420 CT	3970185	-	Incorporated
CB 50/2	3970154	-	Accessory

RLS 100

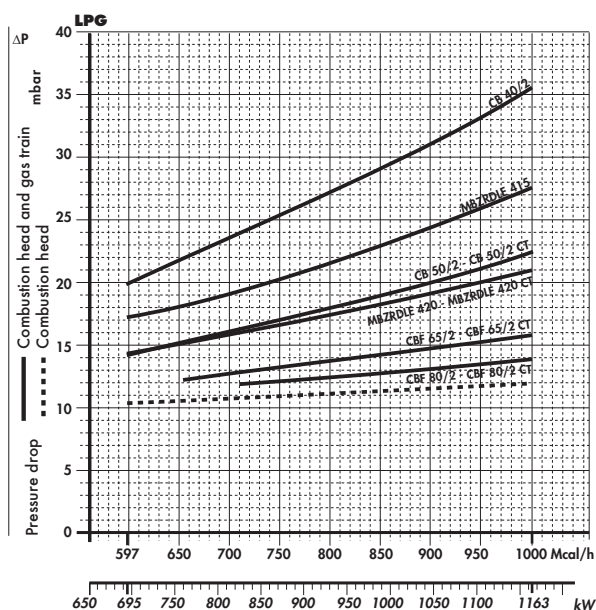

Gas train	Code	Adapter	Seal Control
CB 50/2 CT	3970166	-	Incorporated
CBF 65/2	3970155	3000825	Accessory
CBF 65/2 CT	3970167	3000825	Incorporated
CBF 80/2	3970156	3000826	Accessory
CBF 80/2 CT	3970168	3000826	Incorporated

RLS 130

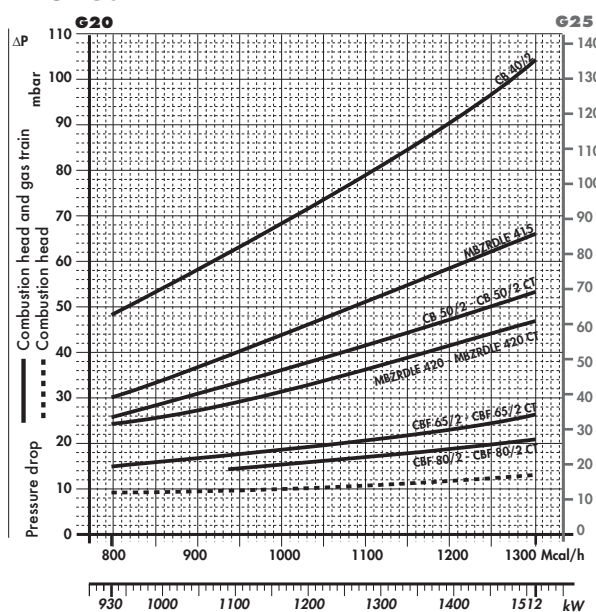

Gas train	Code	Adapter	Seal Control
MBZRDLE 415	3970183	3000843	Accessory
CB 40/2	3970153	3000843	Accessory
MBZRDLE 420	3970184	-	Accessory
MBZRDLE 420 CT	3970185	-	Incorporated
CB 50/2	3970154	-	Accessory

RLS 130

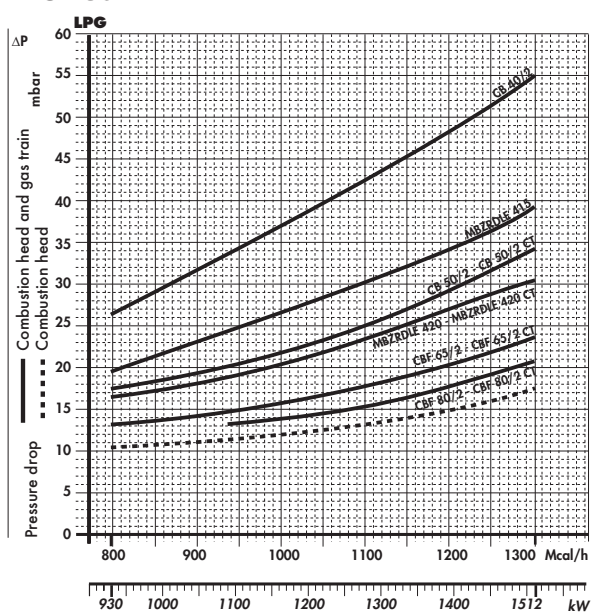

Gas train	Code	Adapter	Seal Control
CB 50/2 CT	3970166	-	Incorporated
CBF 65/2	3970155	3000825	Accessory
CBF 65/2 CT	3970167	3000825	Incorporated
CBF 80/2	3970156	3000826	Accessory
CBF 80/2 CT	3970168	3000826	Incorporated

note Please contact the Riello Burner Technical Office for different pressure levels from those above indicated.



▶ SELECTING THE FUEL SUPPLY LINES

The following diagram enables pressure drop in a pre-existing gas line to be calculated and to select the correct gas train.

The diagram can also be used to select a new gas line when fuel output and pipe length are known. The pipe diameter is selected on the basis of the desired pressure drop. The diagram uses methane gas as reference; if another gas is used, conversion coefficient and a simple formula (on the diagram) transform the gas output to a methane equivalent (refer to figure A). Please note that the gas train dimensions must take into account the back pressure of the combustion chamber during operations.

Control of the pressure drop in an existing gas line or selecting a new gas supply line.

The methane output equivalent is determined by the formula fig. A on the diagram and the conversion coefficient.

Once the equivalent output has been determined on the delivery scale (\dot{V}), shown at the top of the diagram, move vertically downwards until you cross the line that represents the pipe diameter; at this point, move horizontally to the left until you meet the line that represents the pipe length.

Once this point is established you can verify, by moving vertically downwards, the pipe pressure drop on the bottom scale below (mbar).

By subtracting this value from the pressure measured on the gas meter, the correct pressure value will be found for the choice of gas train.

- Example:**
- gas used G25
 - gas output 9.51 mc/h
 - pressure at the gas meter 20 mbar
 - gas line length 15 m
 - conversion coefficient 0.62 (see figure A)

- equivalent methane output $\dot{V} = \left[\frac{9.51}{0.62} \right] = 15.34 \text{ mc/h}$

- once the value of 15.34 has been identified on the output scale (\dot{V}), moving vertically downwards you cross the line that represents 1" 1/4 (the chosen diameter for the piping);
- from this point, move horizontally to the left until you meet the line that represents the length of 15 m of the piping;
- move vertically downwards to determine a value of 1.4 mbar in the pressure drop bottom scale;
- subtract the determined pressure drop from the meter pressure, the correct pressure level will be found for the choice of gas train;
- correct pressure = (20-1.4) = 18.6 mbar

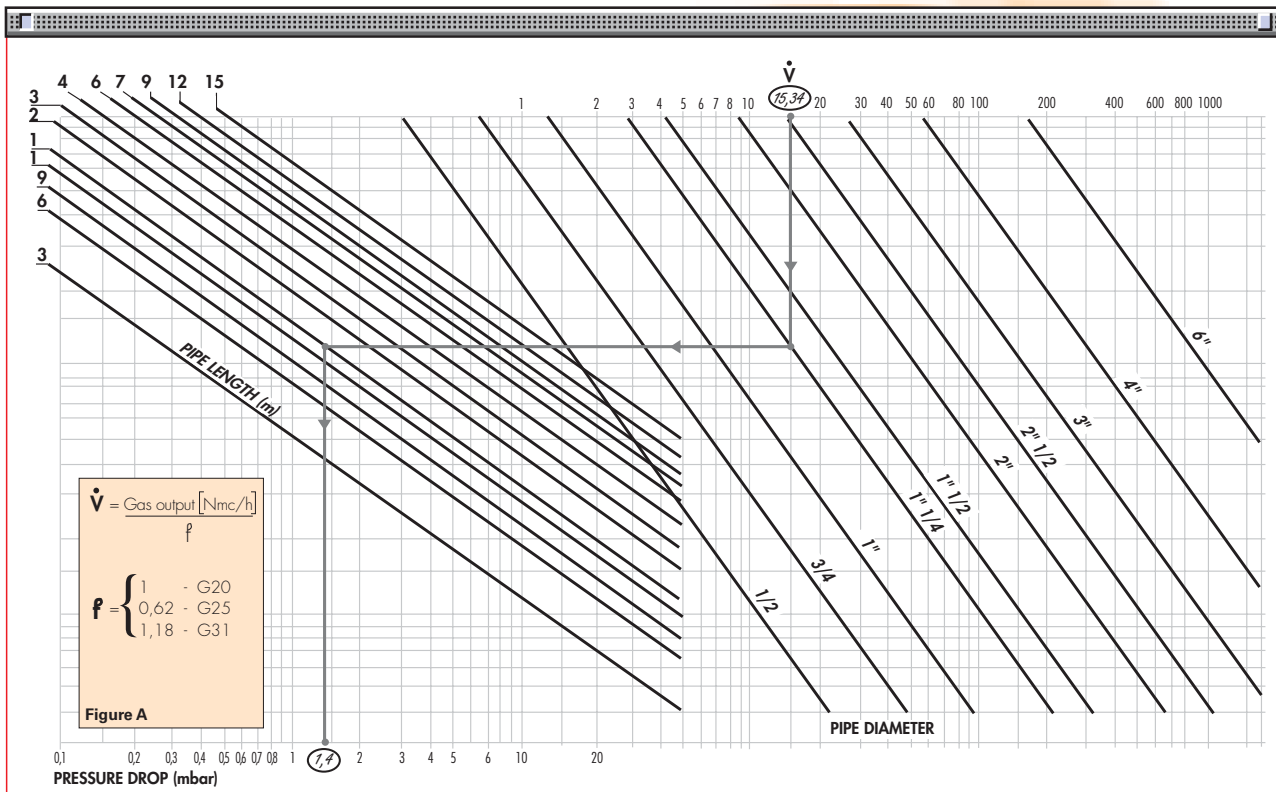

► HYDRAULIC CIRCUIT

The burners are fitted with three valves (a safety valve and two oil delivery valves) along the oil line from the pump to the nozzle.

A thermostatic control device, on the basis of required output, regulates oil delivery valves opening, allowing light oil passage through the valves and to the nozzle. Delivery valves open contemporary to the air damper opening, controlled by a servomotor.

The pumping group is fitted with a pump, an oil filter and a regulating valve: through this it is possible to manually adjust atomised pressure, which is factory set at 12 bar.

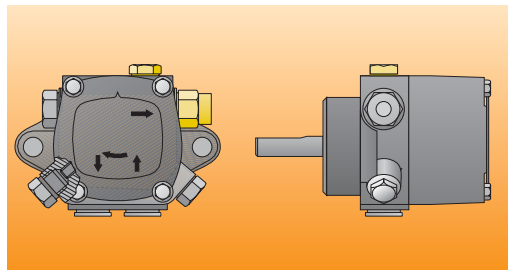

Example of light oil pump of RLS 70-100-130 burners

RLS 28-38-50

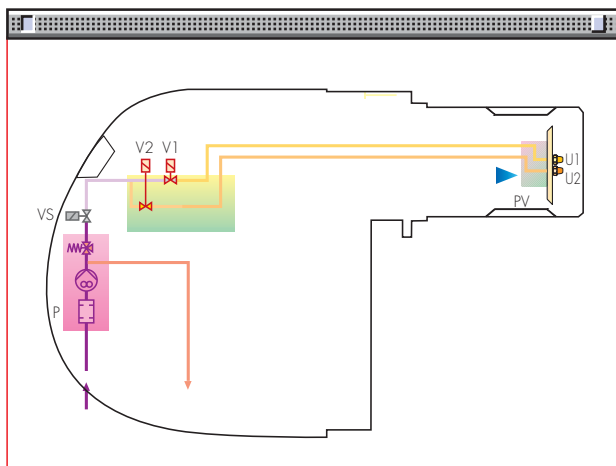

RLS 70-100-130

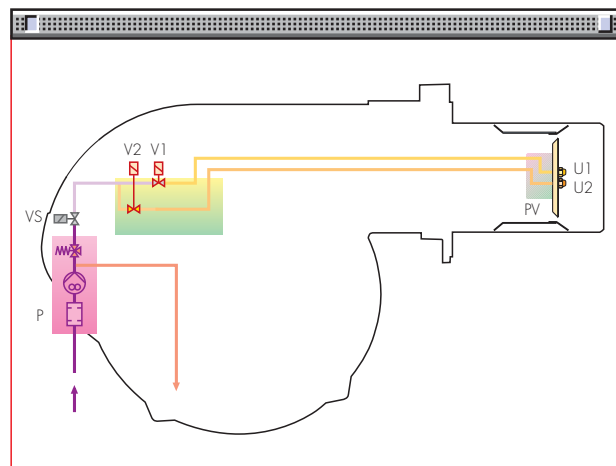

P	Pump with filter and pressure regulator on the output circuit
VS	Safety valve on the output circuit
V1	1st stage valve
V2	2nd stage valve
PV	Nozzle holder
U1	1st stage nozzle
U2	2nd stage nozzle

DIMENSIONING OF THE FUEL SUPPLY LINES

The fuel feed must be completed with the safety devices required by the local norms.

The table shows the choice of piping diameter for the various burners, depending on the difference in height between the burner and the tank and their distance.

MAXIMUM EQUIVALENT LENGTH FOR THE PIPING L[m]						
Model	▼ RLS 28 - 38 - 50			▼ RLS 70 - 100 - 130		
Piping diameter	8mm	10mm	12mm	12mm	14mm	16mm
+H, -H (m)	Lmax (m)	Lmax (m)	Lmax (m)	Lmax (m)	Lmax (m)	Lmax (m)
+4,0	35	90	152	71	138	150
+3,0	30	80	152	62	122	150
+2,0	26	69	152	53	106	150
+1,5	22	54	141	49	98	150
+1,0	21	59	130	44	90	150
+0,5	19	53	119	40	82	150
0	17	48	108	36	74	137
-0,5	15	43	97	32	66	123
-1,0	13	37	83	28	56	109
-1,5	11	32	74	24	49	95
-2,0	9	27	64	19	42	81
-3,0	4	16	42	10	26	53
-4,0	-	6	20	-	10	25

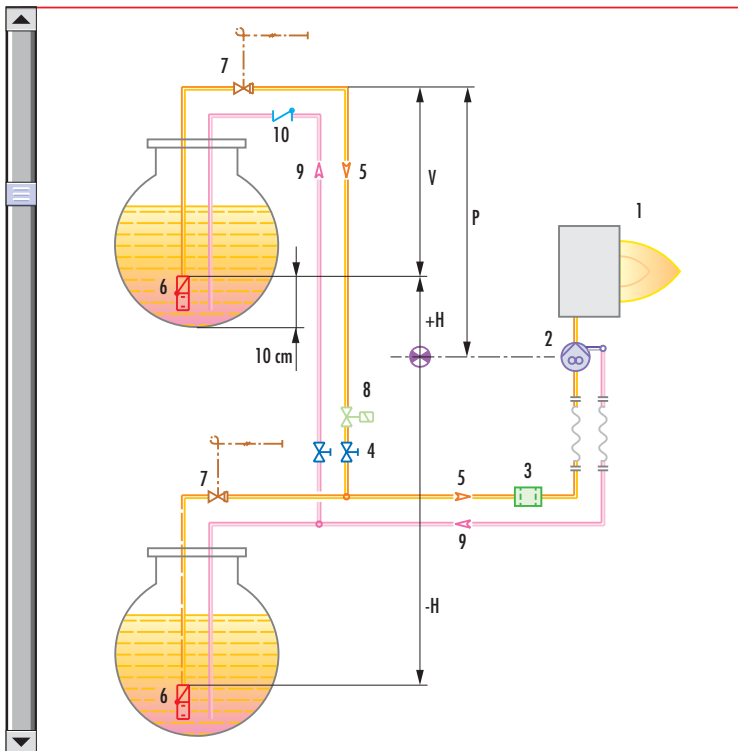

H	Difference in height pump-foot valve
Ø	Internal pipe diameter
P	Height " 10 m
V	Height " 4 m
1	Burner
2	Burner pump
3	Filter
4	Manual shut off valve
5	Suction pipework
6	Bottom valve
7	Remote controlled rapid manual shutoff valve (compulsory in Italy)
8	Type approved shut off solenoid (compulsory in Italy)
9	Return pipework
10	Check valve

note With ring distribution oil systems, the feasible drawings and dimensioning are the responsibility of specialised engineering studios, who must check compatibility with the requirements and features of each single installation.



VENTILATION

The ventilation circuit guarantees low noise levels with high performances in pressure and air delivery, in spite of compact dimensions.

The use of reverse curve blades and sound proofing material keeps noise level very low.

The result is a powerful yet quiet burner with increased combustion performance.

A servomotor allows to have a right air flow in any operation state and the closure of the air damper when burner is in stand-by.

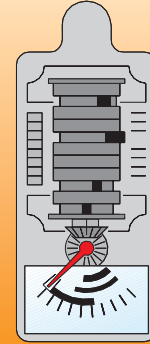

Example of the servomotor for air regulation on RLS 70-100-130 burners.



COMBUSTION HEAD

Different lengths of the combustion head can be supplied (with application of a specific "extended head kit") for the RLS series of burners.

The selection depends on the thickness of the front panel and on the type of boiler.

Depending on the type of generator, check that the penetration of the head into the combustion chamber is correct. The internal position of the combustion head can easily be adjusted to the maximum defined output by regulating a screw fixed to the flange.



Example of RLS 130 burners combustion head.

Dimensions of the flame

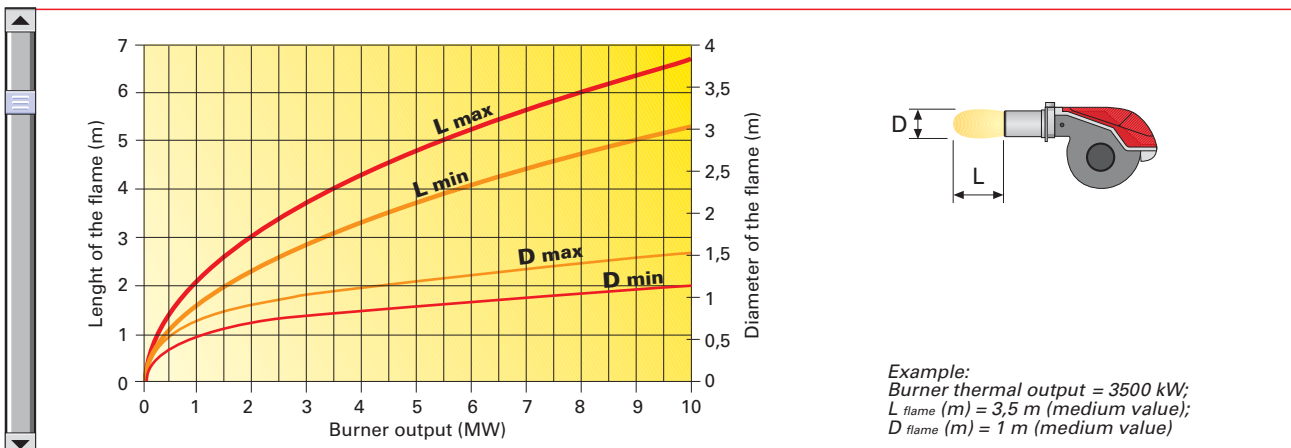

OPERATION



BURNER OPERATION MODE

With two-stage operation, the RLS series of burners can follow the temperature load requested by the system. A modulation ratio of 2:1 is reached thanks to the nozzles when burner is supplied with light oil and to the two-stage gas train when burner is supplied from gas; the air is adapted to the servomotor rotations.

On "two-stage" operation, the burner gradually adjusts output to the requested level, by varying between two pre-set levels (see picture A).

Two stage operation

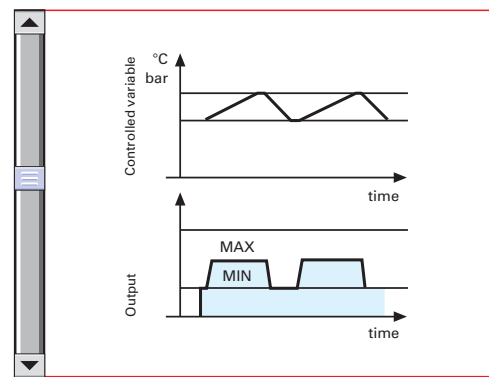

Picture A

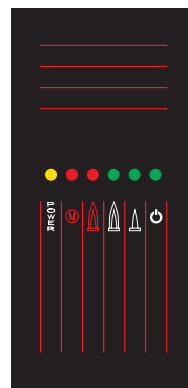

- = Power on
- = Fan motor blocked (red)
- = Burner lock-out (red)
- = 2nd stage operation
- = 1st stage operation
- = Burner operating

Picture B: Layout of "Led Panel"

The RLS burners are equipped with an exclusive electronic device "Led panel" that provides the six data items signalled by the leds lighting up of picture B.

START UP CYCLE

RLS 28 - 38 - 50 - 70 - 100 - 130

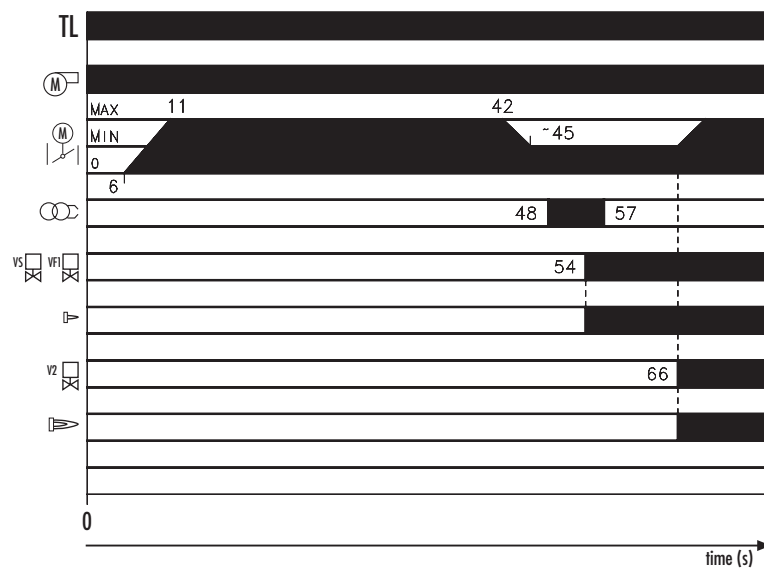

- 0" Thermostat closes. The motor starts running.
- 6"-11" The servomotor opens the air damper.
- 11"-42" Pre-purge with air damper open.
- 42"-45" The servomotor takes the air damper to the firing position.
- 48" Pre-ignition
- 54" Solenoid security valve VS and V1 1st stage valve open; 1st stage flame
- 57" After 3" firing the ignition transformer switches off (if flame is detected, otherwise there is a lock-out)
- 66" If heat request is not yet satisfied, 2nd stage solenoid valve V2 opens and at the same time servomotor open completely the air damper. The starting cycle comes to an end. 2nd stage flame.





WIRING DIAGRAMS

Electrical connections must be made by qualified and skilled personnel, according to the local norms.



Example of the terminal board for electrical connections for RLS 28-38 burner models

TWO STAGE OPERATION

RLS 28-38
Without seal control

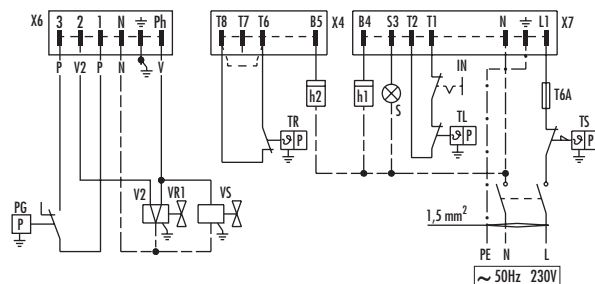

- h1** - 1st stage hourcounter
- h2** - 2nd stage hourcounter
- IN** - Burner manual stop switch
- XP** - Plug for seal control device
- X4** - 4 pole plug
- X6** - 6 pole plug
- X7** - 7 pole plug
- PG** - Min gas pressure switch
- S** - Remote lock-out signal
- S1** - Remote lock-out signal of seal control device
- TR** - High-low mode load remote control system
- TL** - Load limit remote control system
- TS** - Safety load control system
- VR1** - Regulating valve 1st stage
- VR2** - Regulating valve 2nd stage
- VS** - Safety valve

RLS 28-38
With seal control

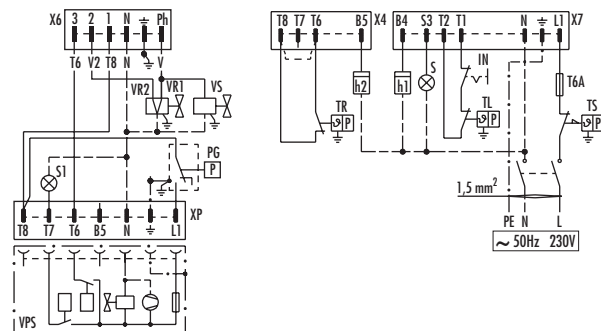

- h1** - 1st stage hourcounter
- h2** - 2nd stage hourcounter
- IN** - Burner manual stop switch
- XP** - Plug for seal control device
- X4** - 4 pole plug
- X6** - 6 pole plug
- X7** - 7 pole plug
- PG** - Min gas pressure switch
- S** - Remote lock-out signal
- S1** - Remote lock-out signal of seal control device
- TR** - High-low mode load remote control system
- TL** - Load limit remote control system
- TS** - Safety load control system
- VR1** - Regulating valve 1st stage
- VR2** - Regulating valve 2nd stage
- VS** - Safety valve



RLS 50 Without seal control

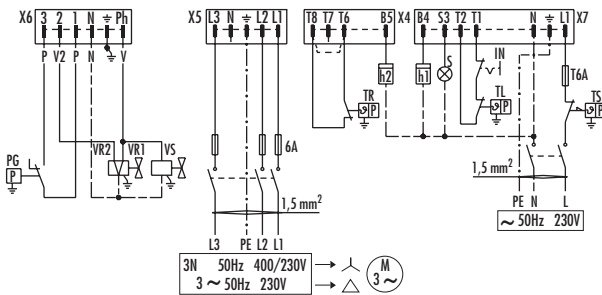

- h1** - 1st stage hourcounter
- h2** - 2nd stage hourcounter
- IN** - Burner manual stop switch
- XP** - Plug for seal control device
- X4** - 4 pole plug
- X5** - 5 pole plug
- X6** - 6 pole plug
- X7** - 7 pole plug
- PG** - Min gas pressure switch
- S** - Remote lock-out signal
- S1** - Remote lock-out signal of seal control device
- TR** - High-low mode load remote control system
- TL** - Load limit remote control system
- TS** - Safety load control system
- VR1** - Regulating valve 1st stage
- VR2** - Regulating valve 2nd stage
- VS** - Safety valve

RLS 50 With seal control

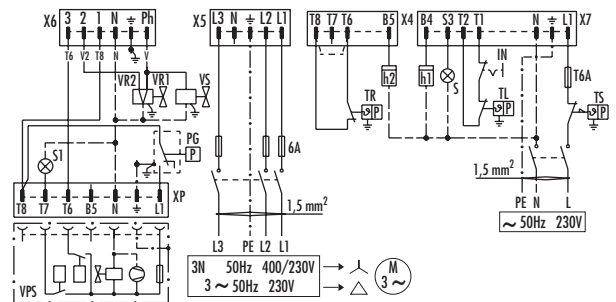

- h1** - 1st stage hourcounter
- h2** - 2nd stage hourcounter
- IN** - Burner manual stop switch
- XP** - Plug for seal control device
- X4** - 4 pole plug
- X5** - 5 pole plug
- X6** - 6 pole plug
- X7** - 7 pole plug
- PG** - Min gas pressure switch
- S** - Remote lock-out signal
- S1** - Remote lock-out signal of seal control device
- TR** - High-low mode load remote control system
- TL** - Load limit remote control system
- TS** - Safety load control system
- VR1** - Regulating valve 1st stage
- VR2** - Regulating valve 2nd stage
- VS** - Safety valve

RLS 70-100-130 Without seal control

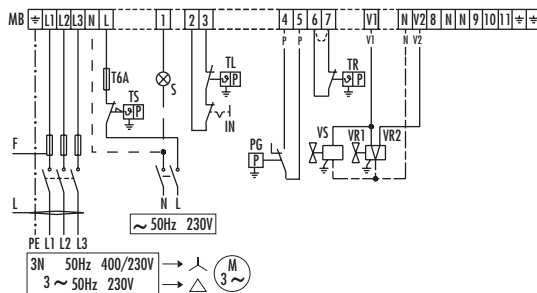

- IN** - Burner manual stop switch
- XP** - Plug for seal control device
- MB** - Burner terminal board
- PG** - Min gas pressure switch
- S** - Remote lock-out signal
- S1** - Remote lock-out signal of seal control device
- TR** - High-low mode load remote control system
- TL** - Load limit remote control system
- TS** - Safety load control system
- VR1** - Regulating valve 1st stage
- VR2** - Regulating valve 2nd stage
- VS** - Safety valve

RLS 70-100-130 With seal control

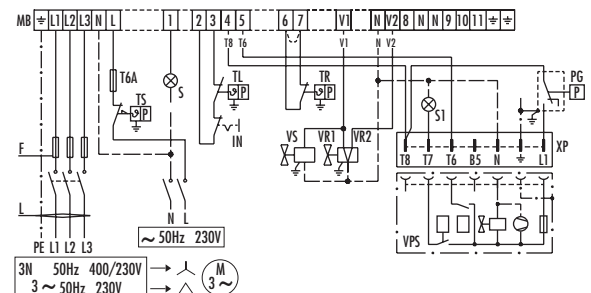

- IN** - Burner manual stop switch
- XP** - Plug for seal control device
- MB** - Burner terminal board
- PG** - Min gas pressure switch
- S** - Remote lock-out signal
- S1** - Remote lock-out signal of seal control device
- TR** - High-low mode load remote control system
- TL** - Load limit remote control system
- TS** - Safety load control system
- VR1** - Regulating valve 1st stage
- VR2** - Regulating valve 2nd stage
- VS** - Safety valve

The following table shows the supply lead sections and the type of fuse to be used.

Model	▼ RLS 28	▼ RLS 38	▼ RLS 50		▼ RLS 70		▼ RLS 100		▼ RLS 130	
	230V	230V	230V	400V	230V	400V	230V	400V	230V	400V
F A	T6	T6	T10	T6	T10	T6	T10	T6	T10	T6
L mm ²	1,5	1,5	1,5	1,5	1,5	1,5	1,5	1,5	1,5	1,5

Table A



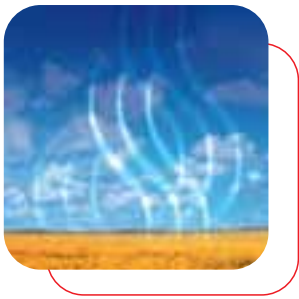

EMISSIONS



NO_x EMISSIONS

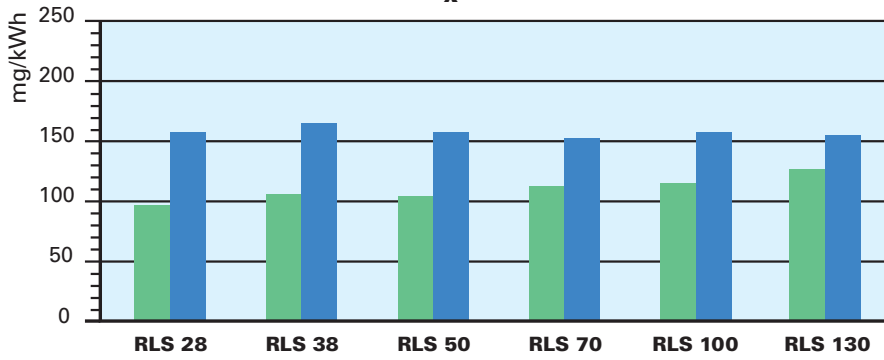

Gas working
Light oil working

CO EMISSIONS

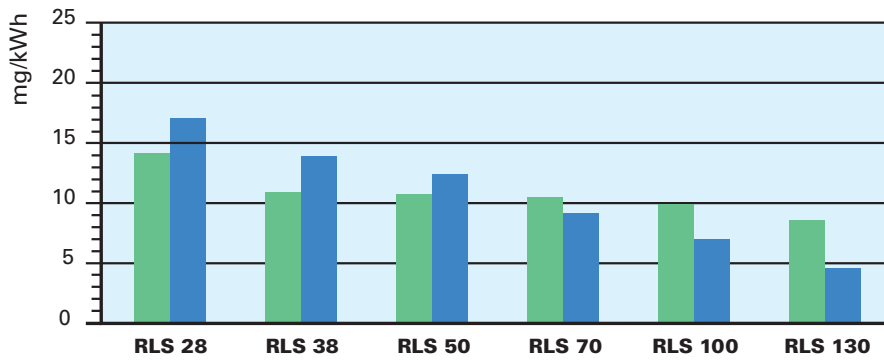

The emission data has been measured in the various models at maximum output, according to EN 676 and EN 267 standard.

NOISE EMISSIONS

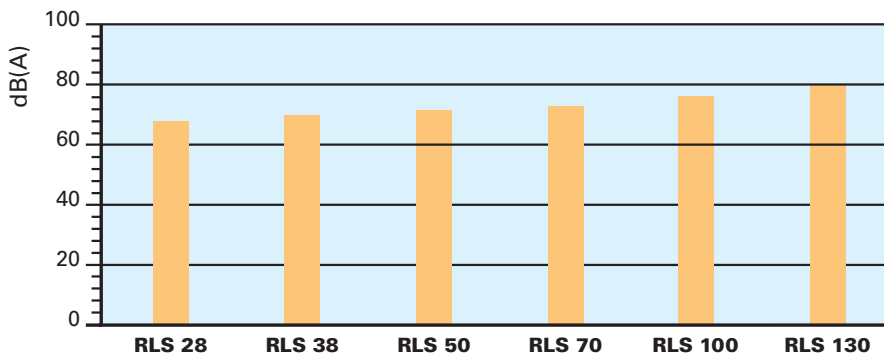

OVERALL DIMENSIONS (mm)



BURNERS

RLS 28 - 38 - 50

RLS 70 - 100 - 130

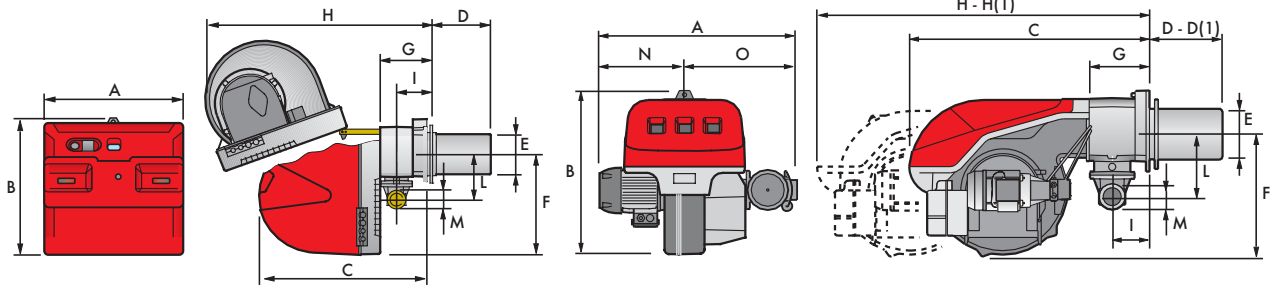

Model	A	B	C	D	D(1)	E	F	G	H	H(1)	I	L	M	N	O
▶ RLS 28	476	474	580	191	326	140	352	164	810	810	108	168	1"1/2	-	-
▶ RLS 38	476	474	580	201	336	152	352	164	810	810	108	168	1"1/2	-	-
▶ RLS 50	476	474	580	216	351	152	352	164	810	810	108	168	1"1/2	-	-
▶ RLS 70	691	555	840	250	385	179	430	214	1161	1361	134	221	2"	296	395
▶ RLS 100	707	555	840	250	385	189	430	214	1161	1361	134	221	2"	312	395
▶ RLS 130	733	555	840	250	385	189	430	214	1161	1361	134	221	2"	338	395

(1) Dimension with "extended head".

BURNER - BOILER MOUNTING FLANGE

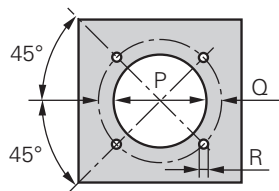

Model	P	Q	R
▶ RLS 28	160	224	M8
▶ RLS 38	160	224	M8
▶ RLS 50	160	224	M8
▶ RLS 70	185	275-325	M12
▶ RLS 100	195	275-325	M12
▶ RLS 130	195	275-325	M12

PACKAGING

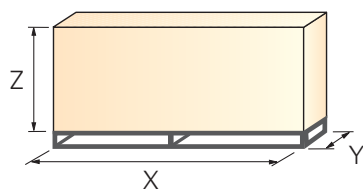

Model	X	Y	Z	kg
▶ RLS 28	1190	492	510	43
▶ RLS 38	1190	492	510	45
▶ RLS 50	1190	492	510	46
▶ RLS 70	1405	1000	660	70
▶ RLS 100	1405	1000	660	73
▶ RLS 130	1405	1000	660	76





INSTALLATION DESCRIPTION

Installation, start up and maintenance must be carried out by qualified and skilled personnel. All operations must be performed in accordance with the technical handbook supplied with the burner.

▶ BURNER SETTING

- ▶ All the burners have slide bars, for easier installation and maintenance.
- ▶ After drilling the boilerplate, using the supplied gasket as a template, dismantle the blast tube from the burner and fix it to the boiler.
- ▶ Adjust the combustion head.
- ▶ Fit the gas train choosing this on the basis of the maximum boiler output and following the diagrams included in the burner instruction handbook
- ▶ Refit the burner casing to the slide bars.
- ▶ Install the nozzle choosing this on the basis of the maximum boiler output and following the diagrams included in the burner instruction handbook.
- ▶ Check the position of the electrodes.
- ▶ Close the burner, sliding it up to the flange, keeping it slightly raised to avoid the flame stability disk rubbing against the blast tube.

▶ ELECTRICAL AND HYDRAULIC CONNECTIONS AND START UP

- ▶ The burners are supplied for connection to two pipes fuel supply system.
- ▶ Connect the ends of the flexible pipes to the suction and return pipework using the supplied nipples.
- ▶ Make the electrical connections to the burner following the wiring diagrams included in the instruction handbook.
- ▶ Prime the pump by turning the motor (after checking rotation direction if it is a three phase motor).
- ▶ Adjust the gas train for first start
- ▶ On start up, check:
 - ▶ Pressure pump and valve unit regulator (to max. and min.)
 - ▶ Gas pressure at the combustion head (to max. and min. output)
 - ▶ Combustion quality, in terms of unburned substances and excess air.

BURNER ACCESSORIES



Nozzles type 60° B

The nozzles must be ordered separately. The following table shows the features and codes on the basis of the maximum required fuel output.



Nozzles type 60° B					
Burner	GPH	Rated output (kg/h) Nozzle			Code
		at 10 bar	at 12 bar	at 14 bar	
RLS 28	2,00	7,7	8,5	9,2	3042126
RLS 28-38	2,50	9,6	10,6	11,5	3042140
RLS 28-38-50	3,00	11,5	12,7	13,8	3042158
RLS 28-38-50	3,50	13,5	14,8	16,1	3042162
RLS 38-50	4,00	15,4	17	18,4	3042172
RLS 38-50	4,50	17,3	19,1	20,7	3042182
RLS 38-50-70	5,00	19,2	21,2	23	3042192
RLS 50-70	5,50	21,1	23,3	25,3	3042202
RLS 50-70	6,00	23,1	25,5	27,7	3042212
RLS 50-70	6,50	25	27,6	30	3042222
RLS 70-100	7,00	26,9	29,7	32,3	3042232
RLS 70-100	7,50	28,8	31,8	34,6	3042242
RLS 70-100	8,00	30,8	33,9	36,9	3042252
RLS 70-100	8,50	32,7	36,1	39,2	3042262
RLS 70-100-130	9,50	36,5	40,3	43,8	3042282
RLS 70-100-130	10,00	38,4	42,4	46,1	3042292
RLS 70-100-130	11,00	42,3	46,7	50,7	3042312
RLS 100-130	12,00	46,1	50,9	55,3	3042322
RLS 100-130	13,00	50	55,1	59,9	3042332
RLS 100-130	14,00	53,8	59,4	64,5	3042352
RLS 100-130	15,00	57,7	63,6	69,2	3042362
RLS 100-130	16,00	61,5	67,9	73,8	3042382
RLS 130	17,00	65,4	72,1	78,4	3042392

Extended heads

“Standard head” burners can be transformed into “extended head” versions, by using the special kit. The kits available for the various burners, giving the original and the extended lengths, are listed below.

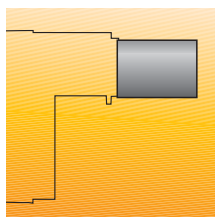

Extended heads			
Burner	'Standard' head length (mm)	'Extended' head length (mm)	Kit code
RLS 28	191	326	3010154
RLS 38	201	336	3010155
RLS 50	216	351	3010156
RLS 70	250	385	3010162
RLS 100	250	385	3010163
RLS 130	250	385	3010164



Degassing unit

To solve problem of air in the oil sucked, two versions of degassing unit are available.



Degassing unit		
Burner	Degassing unit with filter Code	Degassing unit without filter Code
RLS	3010055	3010054

Sound proofing box

If noise emission needs reducing even further, sound-proofing boxes are available, as given in the following table:



Sound proofing box			
Burner	Box type	Average noise reduction [dB(A)] (*)	Box code
RLS 28 - 38 - 50	C1/3	10	3010403
RLS 70 - 100 - 130	C4/5	10	3010404

(*) according to EN 15036-1 standard



GAS TRAIN ACCESSORIES



Seal control kit

To test the valve seals on the gas train, a special "seal control kit" is available.



Seal control kit		
Burner	Gas train	Kit code
RLS 28	MBZRDLE 407 - MBZRDLE 410 - MBZRDLE 412	3010123
	MBZRDLE 415 - MBZRDLE 420 - CB 40/2 - CB 50/2	3010125
RLS 38	MBZRDLE 410 - MBZRDLE 412	3010123
	MBZRDLE 415 - MBZRDLE 420 - CB 40/2 - CB 50/2	3010125
RLS 50	MBZRDLE 410 - MBZRDLE 412	3010123
	MBZRDLE 415 - MBZRDLE 420 - CB 40/2 - CB 50/2	3010125
RLS 70	MBZRDLE 415 - MBZRDLE 420	3010125
	CB 40/2 - CB 50/2 - CBF 65/2 - CBF 80/2	
RLS 100	MBZRDLE 415 - MBZRDLE 420	3010125
	CB 40/2 - CB 50/2 - CBF 65/2 - CBF 80/2	
RLS 130	MBZRDLE 415 - MBZRDLE 420	3010125
	CB 40/2 - CB 50/2 - CBF 65/2 - CBF 80/2	

Stabiliser spring

Accessory springs are available to vary the pressure range of the gas train stabilisers.

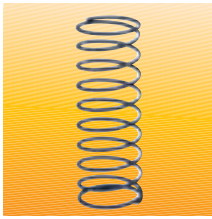

Stabiliser spring		
Gas train	Spring	Code
CBF 65/1 - CBF 80/1	Red from 25 to 55 mbar	3010133
CBF 65/1 - CBF 80/1	Black from 60 to 110 mbar	3010135
CBF 65/1 - CBF 80/1	Pink from 90 to 150 mbar	3090456

Adapters

When the diameter of the gas train is different from the set diameter of the burners, an adapter must be fitted between the gas train and the burner.

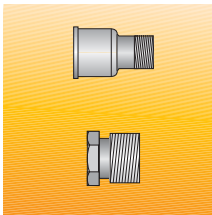

Adapters			
Burner	Gas train	Dimensions	Adapter code
RLS 28	MBZRDLE 407 MBZRDLE 410	3/4" 1" 1/2	3000824
	CB 50/2 - CB 50/2 CT MBZRDLE 420 MBZRDLE 420 CT	2" 1" 1/2	3000822
RLS 38	MBZRDLE 410	3/4" 1" 1/2	3000824
	MBZRDLE 420 MBZRDLE 420 CT	2" 1" 1/2	3000822
	CB 50/2 - CB 50/2 CT		
RLS 50	MBZRDLE 410	3/4" 1" 1/2	3000824
	MBZRDLE 420 MBZRDLE 420 CT	2" 1" 1/2	3000822
	CB 50/2 - CB 50/2 CT		
RLS 70	MBZRDLE 415 - CB 40/2	1" 1/2 2"	3000843
	CBF 65/2 - CBF 65/2 CT	DN 65 2" 1/2 2"	3000825
	CBF 80/2 - CBF 80/2 CT	DN 80 2" 1/2 2"	3000826
RLS 100	MBZRDLE 415 - CB 40/2	1" 1/2 2"	3000843
	CBF 65/2 - CBF 65/2 CT	DN 65 2" 1/2 2"	3000825
	CBF 80/2 - CBF 80/2 CT	DN 80 2" 1/2 2"	3000826
RLS 130	MBZRDLE 415 - CB 40/2	1" 1/2 2"	3000843
	CBF 65/2 - CBF 65/2 CT	DN 65 2" 1/2 2"	3000825
	CBF 80/2 - CBF 80/2 CT	DN 80 2" 1/2 2"	3000826



SPECIFICATION

A specific index guides your choice of burner from the various models available in the RLS series. Below is a clear and detailed specification description of the product.

DESIGNATION OF SERIES

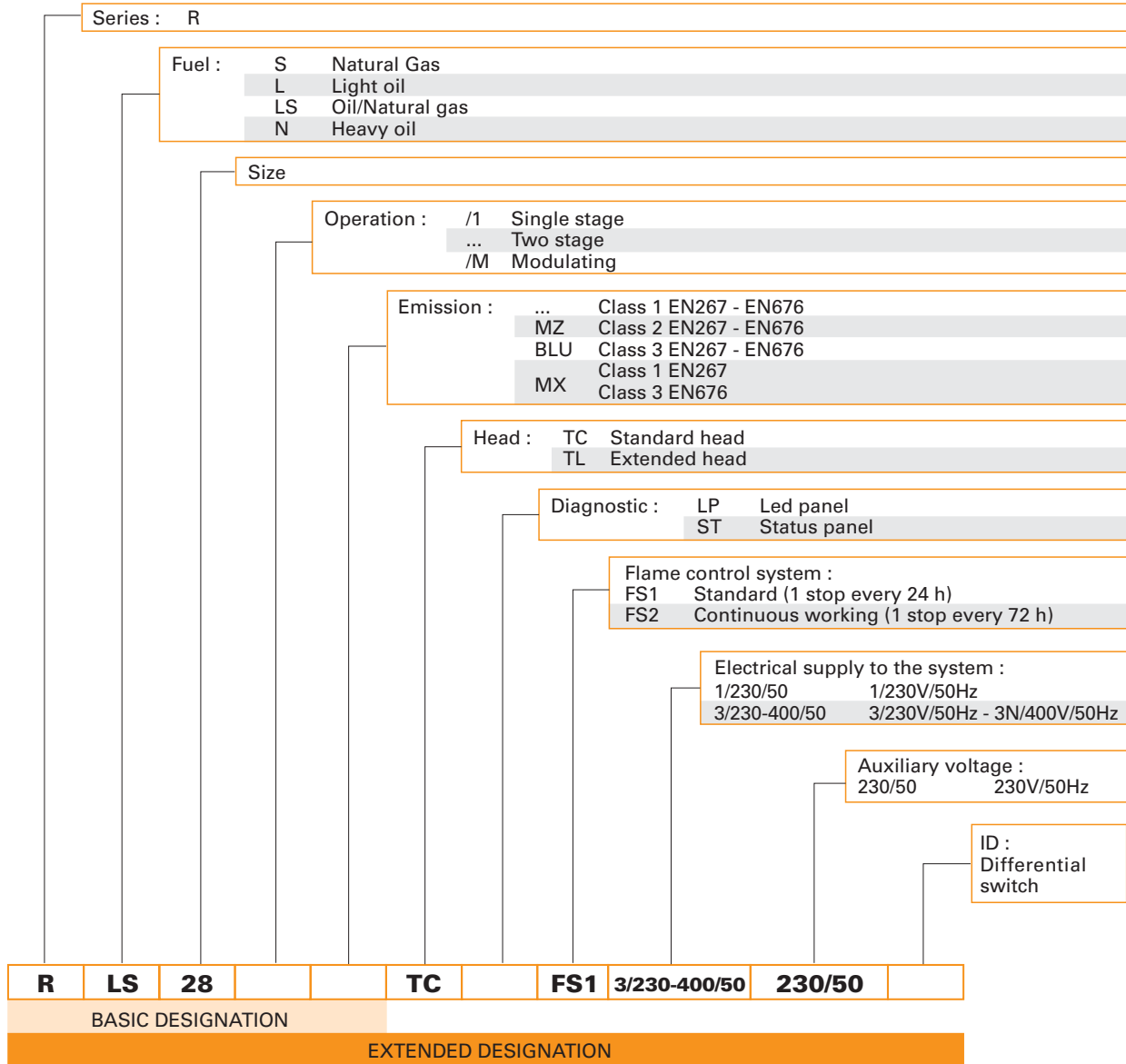

LIST OF AVAILABLE MODELS

RLS 28	TC	LP	FS1	1/230/50	230/50
RLS 38	TC	LP	FS1	1/230/50	230/50
RLS 50	TC	LP	FS1	3/230-400/50	230/50
RLS 70	TC	LP	FS1	3/230-400/50	230/50
RLS 100	TC	LP	FS1	3/230-400/50	230/50
RLS 130	TC	LP	FS1	3/230-400/50	230/50

Other versions are available on request.



▶ **PRODUCT SPECIFICATION**

Burner:

Monobloc forced draught dual fuel burner, two stage operation, made up of:

- Air suction circuit lined with sound-proofing material
- Fan with reverse curve blades
- Fan starting motor
- Air damper for air setting controlled by a servomotor
- Minimum air pressure switch
- Combustion head, that can be set on the basis of required output
- Gears pump for high pressure fuel supply
- Pump starting motor
- Oil safety valves
- Two oil valves (1st and 2nd stage)
- Flame control panel
- Electronic device to check all burners operational modes (Led Panel)
- UV photocell for flame detection
- Burner on/off switch
- Oil/Gas selector
- Manual 1st and 2nd stage switch
- Plugs for electrical connections (RLS 28-38-50)
- Flame inspection window
- Slide bars for easier installation and maintenance
- Protection filter against radio interference
- IP 44 electric protection level.

Conforming to:

- 89/336/EC - 2004/108/EC directive (electromagnetic compatibility)
- 73/23/EC directive (low voltage)
- 92/42/EC directive (performance)
- 98/37/EC directive (machinery)
- EN 267 (liquid fuel burners)
- EN 676 (gas fuel burners).

Standard equipment:

- 1 gas train gasket
- 1 flange gasket
- 4 screws for fixing the flange
- 1 thermal screen
- 4 screws for fixing the burner flange to the boiler
- 2 flexible pipes for connection to the oil supply network
- 2 nipples for connection to the pump with gaskets
- Kit for transformation to LPG
- Fairleads for electrical connections (for RLS 28-38-50 model)
- Instruction handbook for installation, use and maintenance
- Spare parts catalogue.

Available accessories to be ordered separately:

- Nozzles
- Head extension kit
- Degasing unit
- Sound proofing box
- Adapters
- Stabiliser spring
- Seal control kit.



RIELLO S.p.A. - Via Ing. Pilade Riello, 5 - 37045 Legnago (VR) Italy

Tel. ++39.0442630111 - Fax ++39.044221980

Internet: <http://www.rielloburners.com> - E-mail: info@rielloburners.com

Since the Company is constantly engaged in the production improvement, the aesthetic and dimensional features, the technical data, the equipment and the accessories can be changed.

This document contains confidential and proprietary information of RIELLO S.p.A.
Unless authorised, this information shall not be divulged, nor duplicated in whole or in part.