

**LOW NO<sub>x</sub> ONE STAGE GAS BURNERS**

▶ **GULLIVER BS SERIES**

▶ <b>BS1</b>	16 ÷ 52 kW
▶ <b>BS2</b>	35 ÷ 91 kW
▶ <b>BS3</b>	65 ÷ 189 kW
▶ <b>BS4</b>	110 ÷ 246 kW

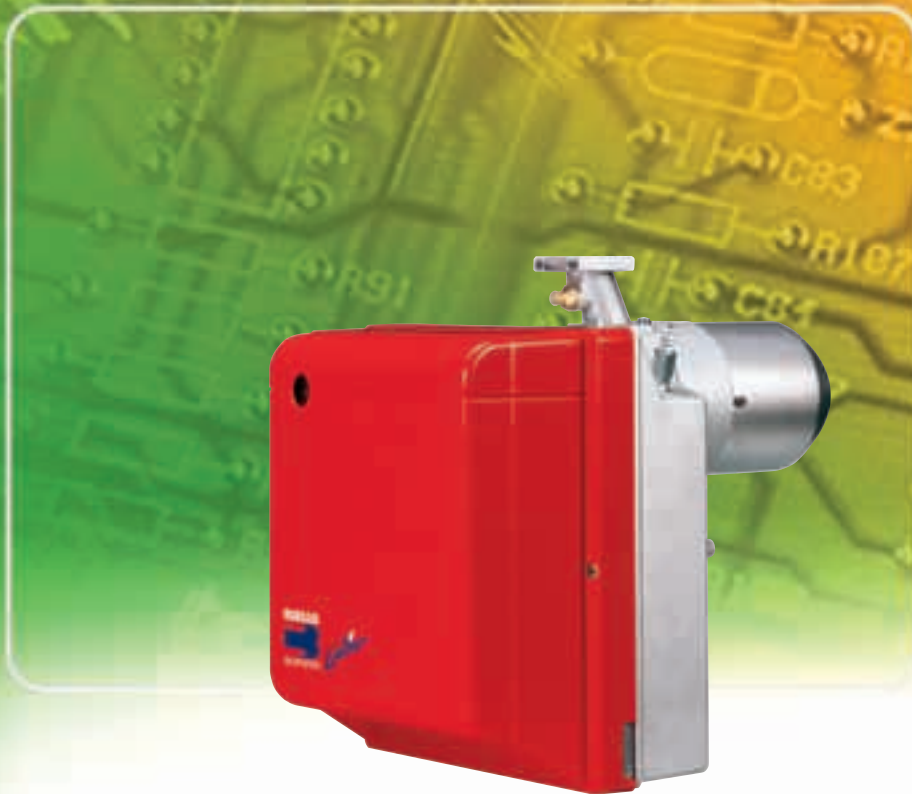

The Riello Gulliver BS series of one stage gas burners, is a complete range of Low NO<sub>x</sub> emission products, developed to respond to any request for home heating, conforming to the most severe standards regarding the reduction of polluting emissions.

This series of burners is available in four different models with an output ranging from 16 to 246 kW, divided in four different structures.

All the models use the same components designed by Riello for the Gulliver series. The high quality level guarantees safe working. The Gulliver BS burners are fitted with a microprocessor - based flame control panel, with diagnostic functions.

In developing these burners, special attention was paid to reducing noise, the ease of installation and adjustment, to obtaining the smallest size possible to fit into any sort of boiler available on the market.

All the models are approved by the EN 676 European Standard and LRV-92 Swiss standards, and conform to BImSchV 1996 and European Directives, Gas Appliance, EMC, Low Voltage, Boiler Efficiency.

All the Gulliver BS burners are tested before leaving the factory.

# TECHNICAL DATA

Model			▼ BS1	▼ BS2	▼ BS3	▼ BS4
Burner operation mode			One stage			
Modulation ratio at max. output			--			
Servomotor	run time	type	--			
		s	--			
Heat output	kW	16 - 52	35 - 91	65 - 189	110 - 246	
	Mcal/h	13,8 - 44,7	30,1 - 78,3	55,9 - 162,5	94,6 - 211,6	
Working temperature		°C min./max.	0/40			
Fuel / air data	Net calorific value G20 gas		kWh/Nm <sup>3</sup> 10			
	G20 gas density		kg/Nm <sup>3</sup> 0,71			
	G20 gas delivery		Nm <sup>3</sup> /h 1,6 - 5,2	3,5 - 9,1	6,5 - 18,9	11 - 24,6
	Net calorific value G25 gas		kWh/Nm <sup>3</sup> 8,6			
	G25 gas density		kg/Nm <sup>3</sup> 0,78			
	G25 gas delivery		Nm <sup>3</sup> /h 1,9 - 6	4 - 10,6	7,6 - 22	12,8 - 28,6
	Net calorific value LPG gas		kWh/Nm <sup>3</sup> 25,8			
	LPG gas density		kg/Nm <sup>3</sup> 2,02			
	LPG gas delivery		Nm <sup>3</sup> /h 0,6 - 2	1,3 - 3,5	2,5 - 7,3	4,3 - 9,5
	Fan		type Centrifugal with forward curve blades			
	Air temperature		max °C 40			
	Electrical data	Electrical supply		Ph/Hz/V 1/50/230 ±10%		
Auxiliary electrical supply		Ph/Hz/V --				
Control box		type MG 569				
Total electrical power		kW 0,150	0,180	0,350	0,530	
Auxiliary electrical power		kW --				
Protection level		IP X0D				
Motor electrical power		kW 0,09	0,09	0,15	0,25	
Rated motor current		A 0,64	0,67	1,4	2	
Motor start up current		A 2,6	2,7	5,6	8	
Motor protection level		IP 20				
Emissions	Ignition transformer		type Incorporated in the control box			
			V1 - V2 ( - ) - 8 kV			
			I1 - I2 ( - ) - 12 mA			
	Operation		Intermittent (at least one stop every 24 h)			
	Sound pressure		dB (A) 61	62	66	71
Sound power		W --				
CO emission		mg/kWh < 40				
NOx emission		mg/kWh < 80				
Approval	Directive		90/396/EEC, 89/336/EEC, 73/23/EEC, 98/37/EEC, 92/42/EEC			
	Conforming to		EN 676 - LRV 92 - BImSchV 1996			
	Certification		CE - 0085 AQ0409 BUWAL - Nr.100010	CE - 0085 AQ0409 BUWAL - Nr.197011	CE - 0085 AQ0409 BUWAL - Nr.100010	CE - 0085 AQ0409 BUWAL - Nr.100010

## Reference conditions:

Temperature: 20°C

Pressure: 1013,5 mbar

Altitude: 100 m a.s.l.

Noise measured at a distance of 1 meter.

Since the Company is constantly engaged in the production improvement, the aesthetic and dimensional features, the technical data, the equipment and the accessories can be changed.

This document contains confidential and proprietary information of RIELLO S.p.A. Unless authorised, this information shall not be divulged, nor duplicated in whole or in part.

# FIRING RATES

EN 676

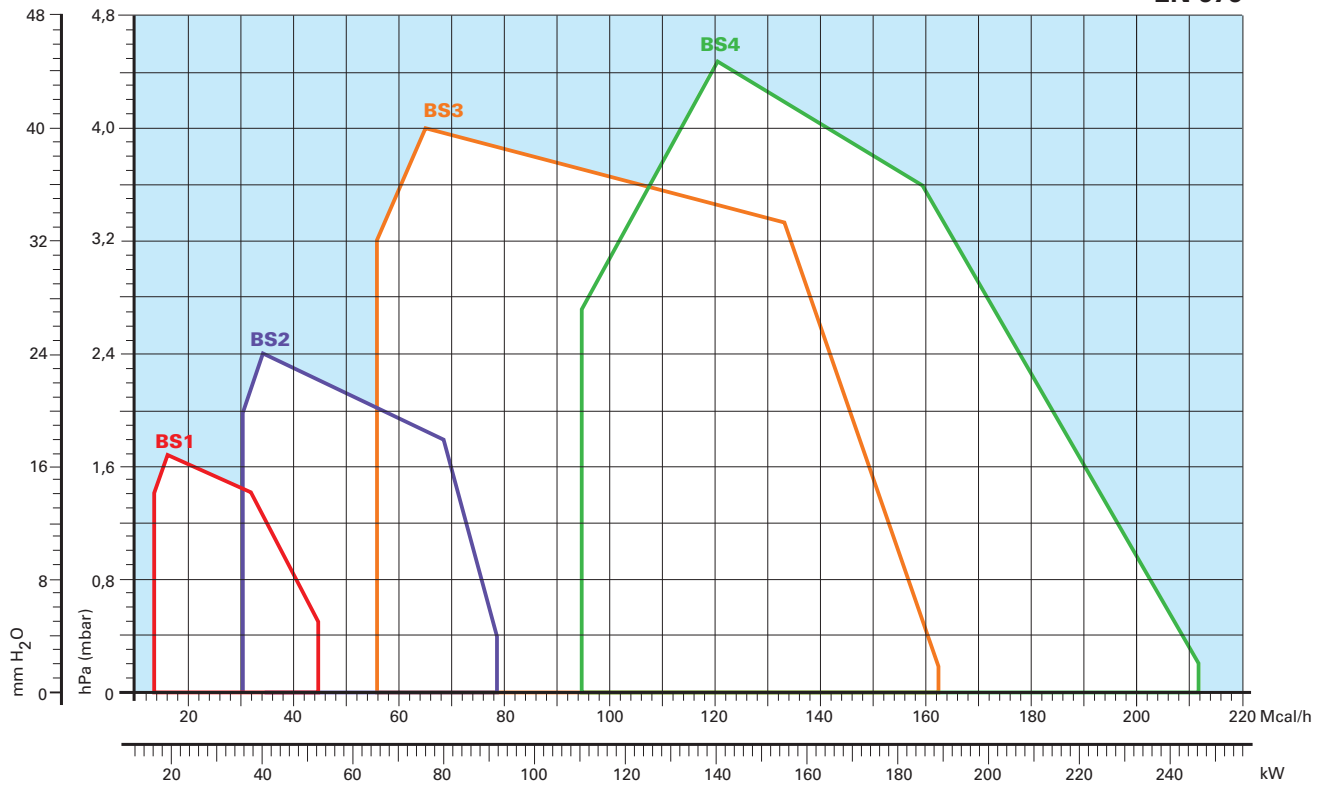

LRV 92

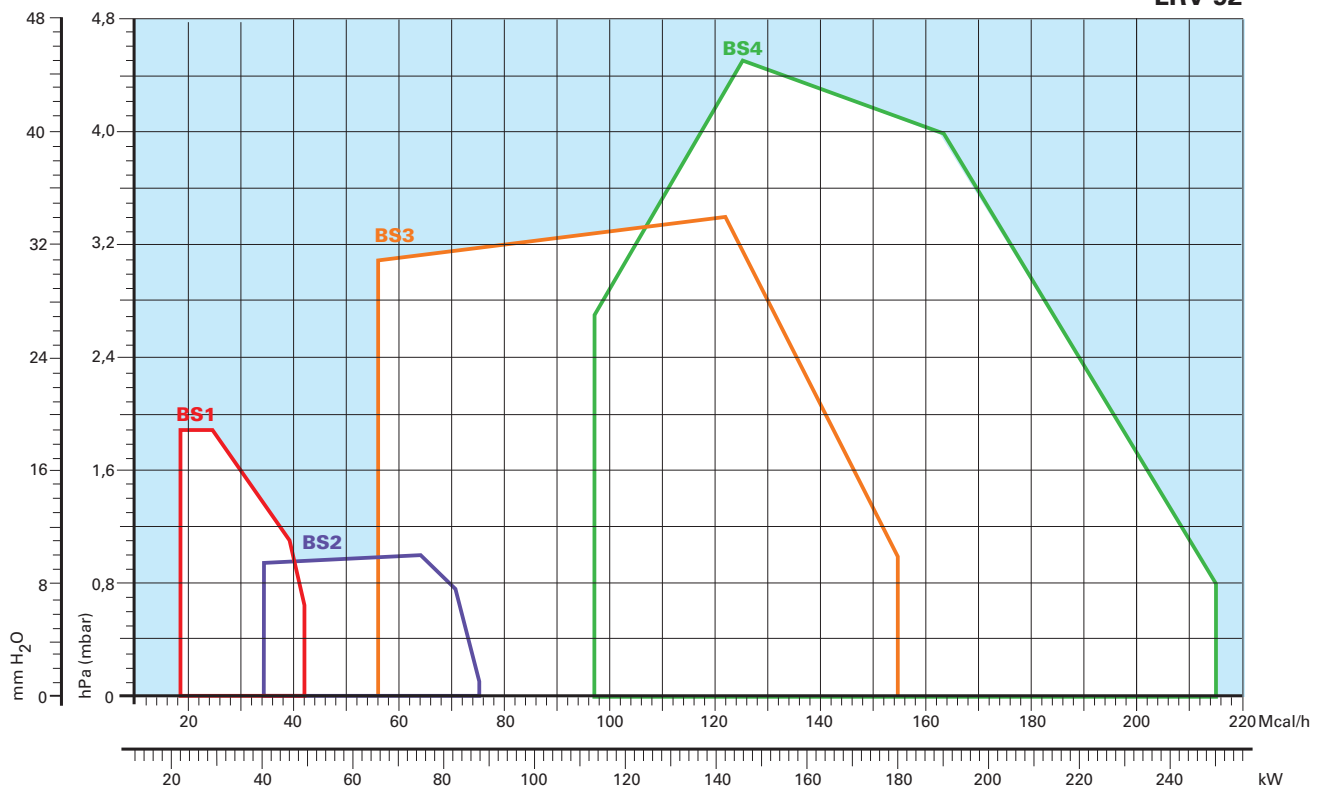

Useful working field for choosing the burner

Test conditions conforming to EN 676 and LRV 92:

Temperature: 20 °C  
 Pressure: 1013,5 mbar  
 Altitude: 100 m a.s.l.





## FUEL SUPPLY

### GASTRAIN

The burners are set for fuel supply from either the right or left hand sides.

Depending on the fuel output and the available pressure in the supply line, you should check the correct gas train to be adapted to the system requirements.

The gas train is Multibloc type, containing the main components in a single unit. Except for the MBC 65 DLE model, a valve seal control (as accessory) can be fitted to the Multibloc gas trains.

The MBC 65 DLE Multibloc gas train can be fitted only to the left of the burner.



Gas train installed on the burner

### MBDLE 403 - 405 - 407 - 410 - 412

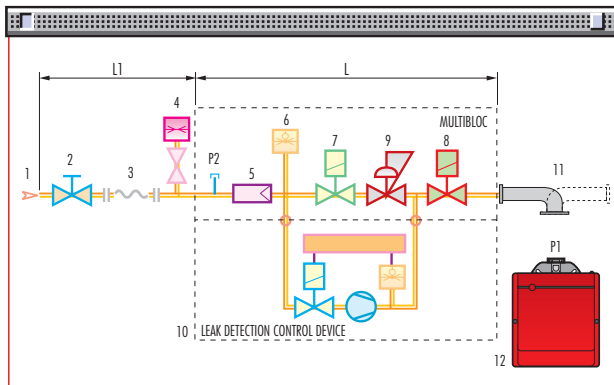

### MBC 65 DLE

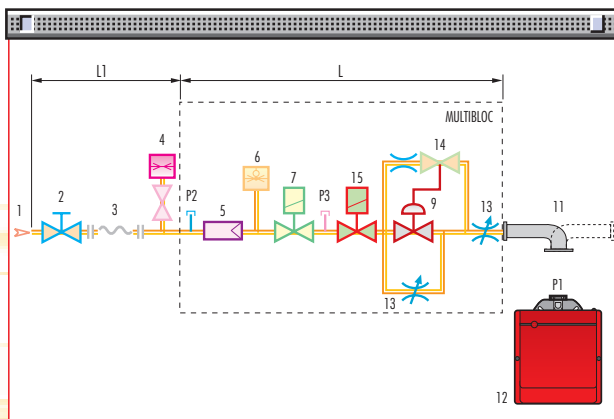

1	Gas delivery pipe
2	Manual valve
3	Vibration damping joint
4	Gas pressure gauge
5	Filter
6	Gas pressure switch
7	Safety solenoid
8	Adjustment solenoid: firing delivery adjustment (rapid opening) maximum delivery adjustment (slow opening)
9	Pressure regulator
10	Leak detection control device for valves 7 and 8 (accessory)
11	Gas train-burner adapter
12	Burner
13	Shutter with adjustment screws
14	Pressure regulator setting device
15	Regulation solenoid
P1	Combustion head pressure
P2	Upstream pressure from the filter
P3	Upstream pressure from the control valve
L	Gas train supplied separately
L1	To be performed by the installer

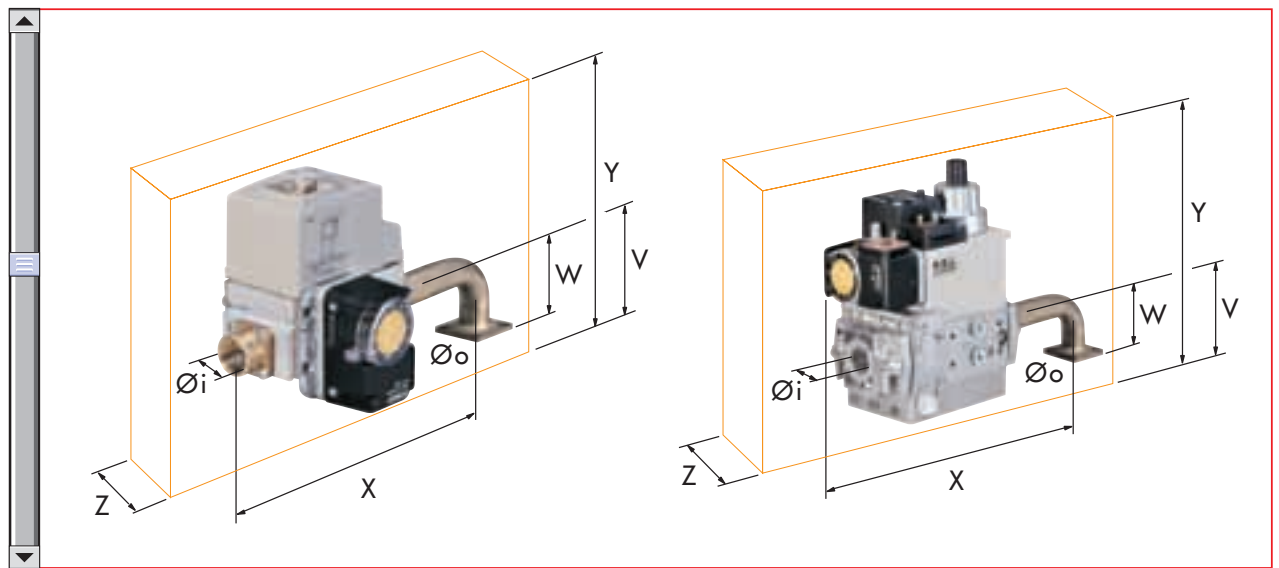

The dimensions of the gas trains vary depending on their construction features. The following table shows the dimensions of the gas trains that can be fitted to Gulliver BS burners, intake diameter and the coupling flange to the burner.

	Name	Code	Ø i	Ø o	X mm	Y mm	W mm	Z mm	V mm	mbar max*
<b>MULTIBLOC</b>	<b>MBC 65 DLE</b>	3970570	1/2"	FLANGE 1	232	126	45	122	31	65
	<b>MBDLE 403</b>	3970545	1/2"	FLANGE 1	200	137	45	100	26	200
	<b>MBDLE 405</b>	3970546	1/2"	FLANGE 1	246	186	45	120	46	300
	<b>MBDLE 405</b>	3970547	3/4"	FLANGE 2	236	186	47	120	46	300
	<b>MBDLE 407</b>	3970544	3/4"	FLANGE 2	236	186	47	120	46	300
	<b>MBDLE 407</b>	3970548	3/4"	FLANGE 3	236	186	47	120	46	300
	<b>MBDLE 410</b>	3970549	1" 1/4	FLANGE 3	259	215	47	145	55	300
	<b>MBDLE 412</b>	3970550	1" 1/4	FLANGE 3	259	215	47	145	55	300

\* max inlet gas pressure (mbar)



## ► PRESSURE DROP DIAGRAM

The diagrams indicate the minimum pressure drop of the burners with the various gas trains that can be combined with them; the value thus calculated represents the minimum required input pressure to the gas train.

### NATURAL GAS

#### BS1

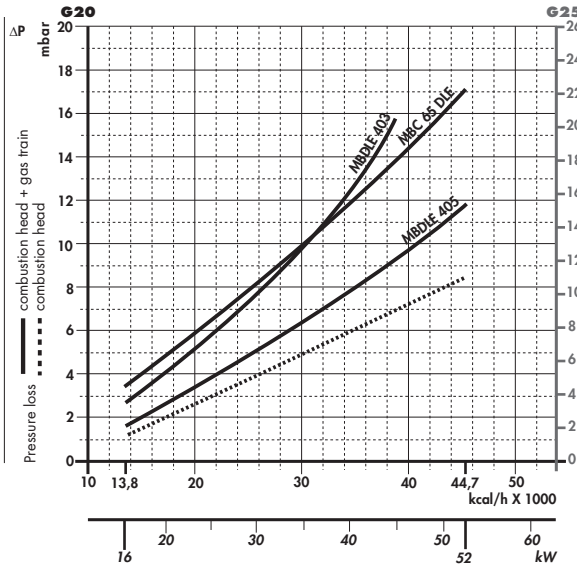

Gas Train	Code	Output	Plug and socket
MBDL E 403	3970545	≤ 45 kW *	•
MBDL E 405	3970546	-	•
MBC 65 DLE	3970570	-	•

\* with natural gas.

### LPG

#### BS1

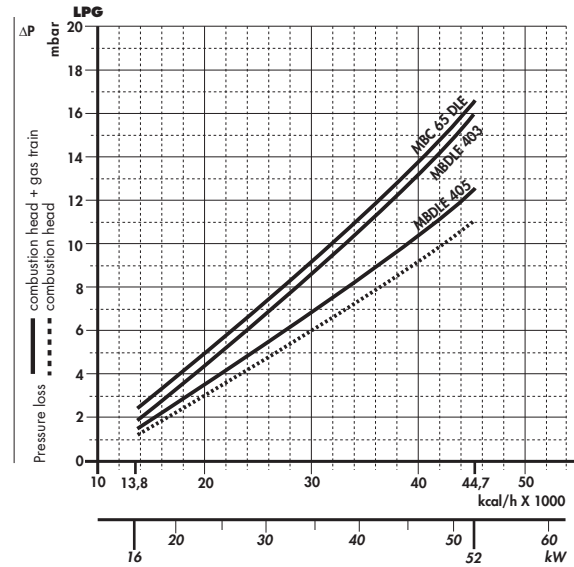

#### BS2

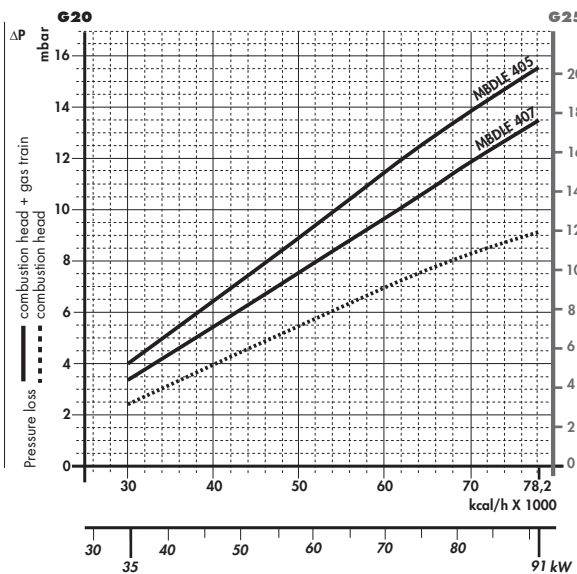

Gas Train	Code	Plug and socket
MBDL E 405	3970547	•
MBDL E 407	3970544	•

#### BS2

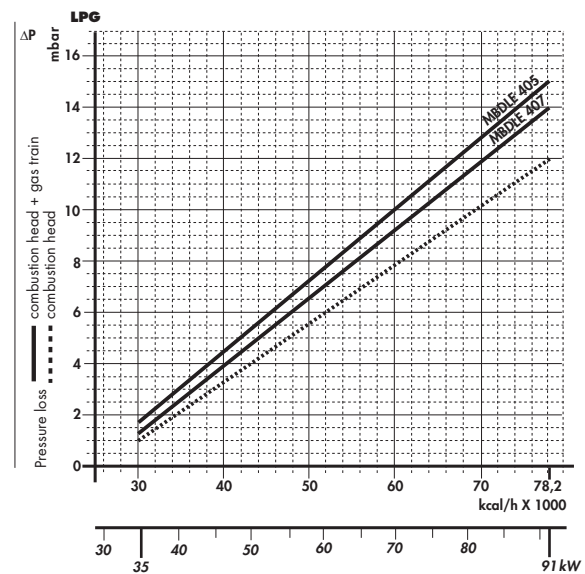

## NATURAL GAS

### BS3

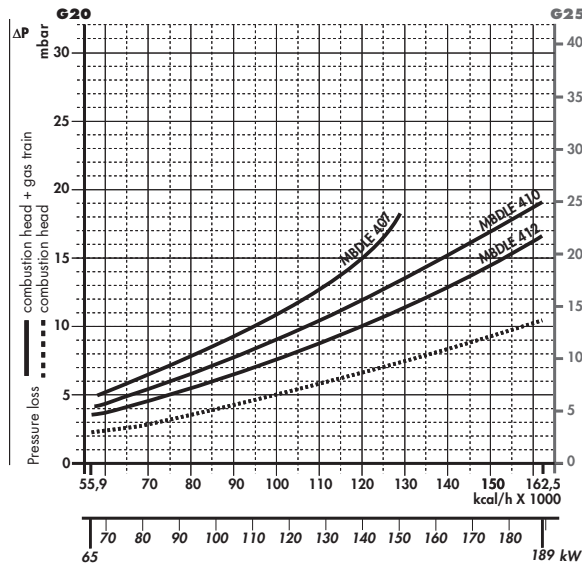

Gas Train	Code	Output	Plug and socket
MBDLE 407	3970548	≤ 150 kW *	•
MBDLE 410	3970549	-	•
MBDLE 412	3970550	-	•

\* with natural gas.

## LPG

### BS3

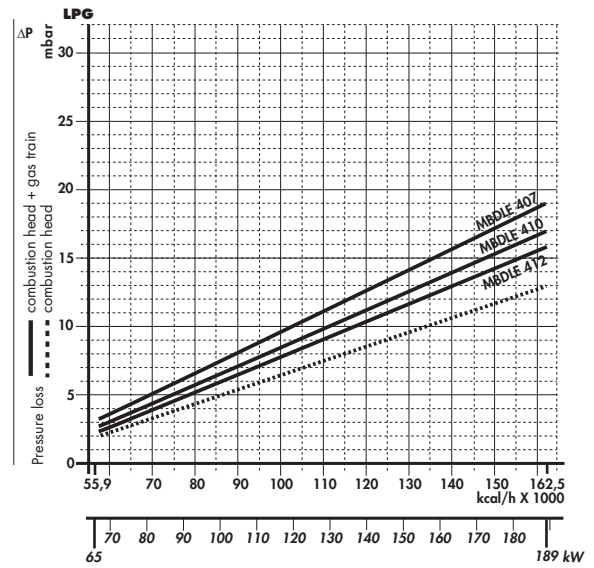

### BS4

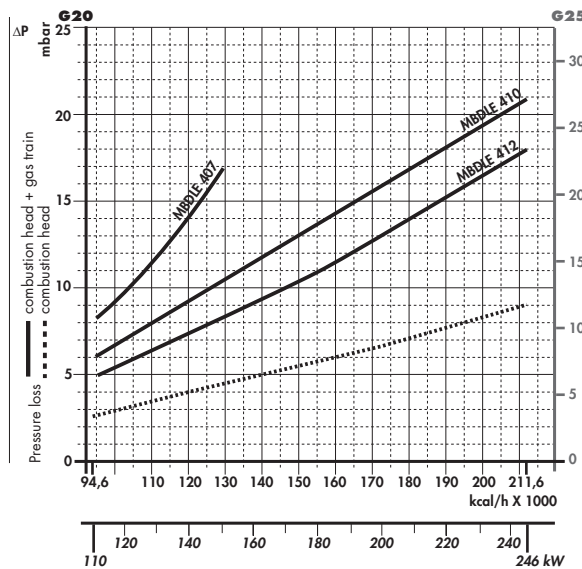

Gas Train	Code	Output	Plug and socket
MBDLE 407	3970548	≤ 150 kW *	•
MBDLE 410	3970549	-	•
MBDLE 412	3970550	-	•

\* with natural gas.

### BS4

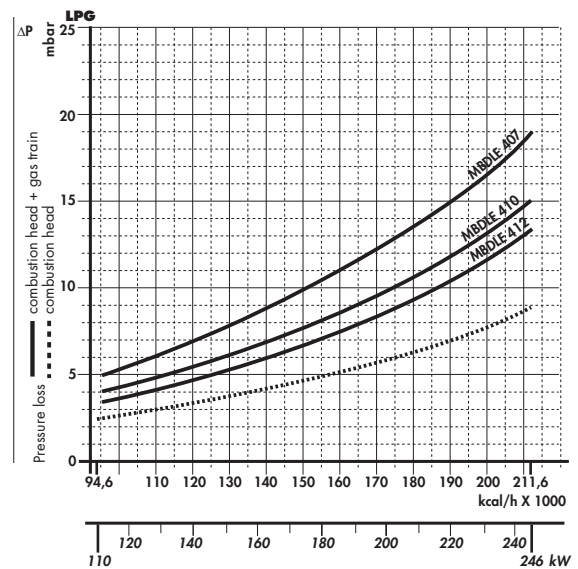

**note** For pressure levels different from those indicated above, please contact Riello Burners Technical Office.  
In LPG plants, Multibloc gas trains do not operate below 0°C.  
They are only suitable for gaseous LPG (liquid hydrocarbons destroy the seal materials).





## SELECTING THE FUEL SUPPLY LINES

The following diagram enables pressure drop in a pre-existing gas line to be calculated and to select the correct gas train.

The diagram can also be used to select a new gas line when fuel output and pipe length are known. The pipe diameter is selected on the basis of the desired pressure drop. The diagram uses methane gas as reference; if another gas is used, conversion coefficient and a simple formula (on the diagram) transform the gas output to a methane equivalent (refer to figure A). Please note that the gas train dimensions must take into account the back pressure of the combustion chamber during operations.

### Control of the pressure drop in an existing gas line or selecting a new gas supply line.

The methane output equivalent is determined by the formula fig. A on the diagram and the conversion coefficient.

Once the equivalent output has been determined on the delivery scale ( $\dot{V}$ ), shown at the top of the diagram, move vertically downwards until you cross the line that represents the pipe diameter; at this point, move horizontally to the left until you meet the line that represents the pipe length. Once this point is established you can verify, by moving vertically downwards, the pipe pressure drop on the bottom scale (mbar).

By subtracting this value from the pressure measured on the gas meter, the correct pressure value will be found for the choice of gas train.

- Example:**
- gas used G25
  - gas output 9.51 mc/h
  - pressure at the gas meter 20 mbar
  - gas line length 15 m
  - conversion coefficient 0.62 (see figure A)

- equivalent methane output  $\dot{V} = \left[ \frac{9.51}{0.62} \right] = 15.34 \text{ mc/h}$

- once the value of 15.34 has been identified on the output scale ( $\dot{V}$ ), moving vertically downwards you cross the line that represents 1" 1/4 (the chosen diameter for the piping);
- from this point, move horizontally to the left until you meet the line that represents the length of 15 m of the piping;
- move vertically downwards to determine a value of 1.4 mbar in the pressure drop bottom scale;
- subtract the determined pressure drop from the meter pressure, the correct pressure level will be found for the choice of gas train;
- correct pressure = ( 20-1.4 ) = 18.6 mbar

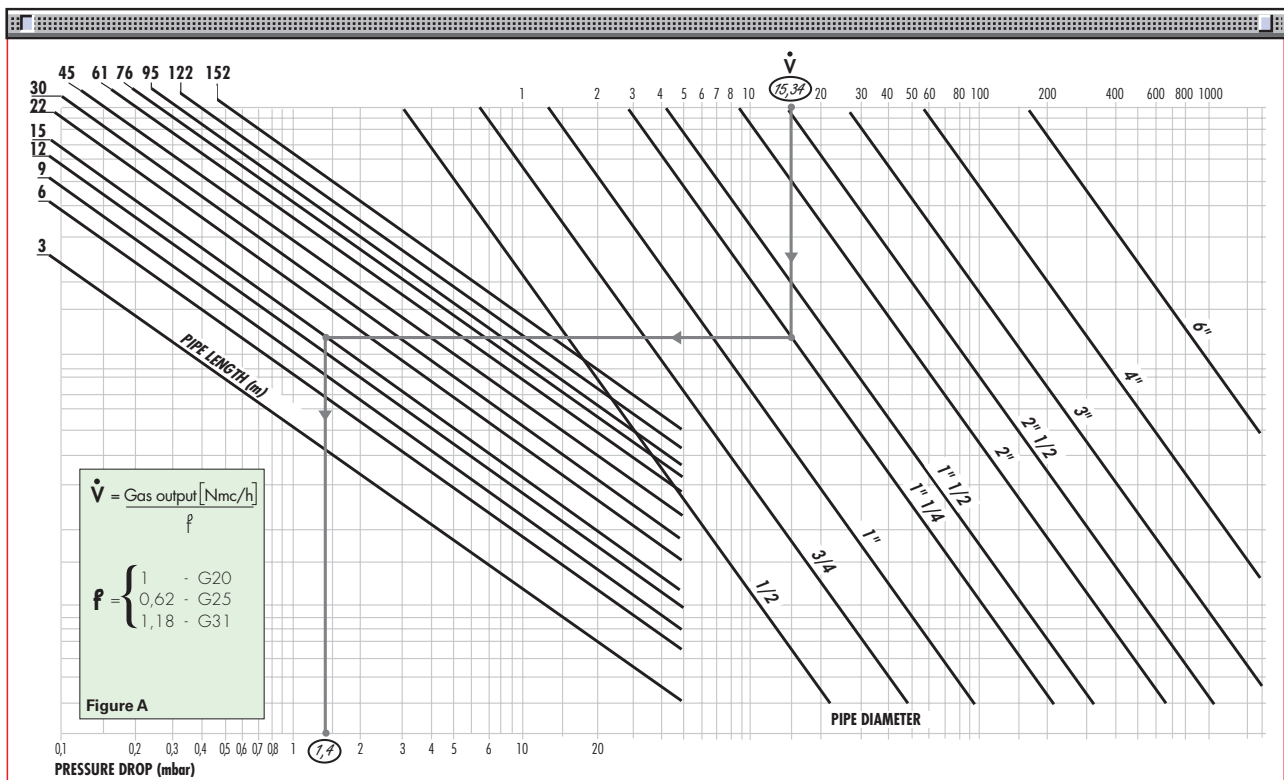



## VENTILATION



The different ventilation circuits always ensure low noise levels with high performance of pressure and air delivery, inspite of their compact size.



Air suction



Air pressure switch

The burners are fitted with an adjustable air pressure switch, conforming to EN 676 standards.

## COMBUSTION HEAD



The combustion head in Gulliver BS burners is the result of an innovative design, which allows combustion with low polluting emissions, while being easy to adapt to all the various types of boilers and combustion chambers.



Combustion head



Mobile flange

Thanks to the use of a mobile coupling flange, the penetration of the head into the combustion chamber can be adjusted.

Simple adjustment allows the internal geometry of the combustion head to be adapted to the burner output.

### Dimensions of the flame

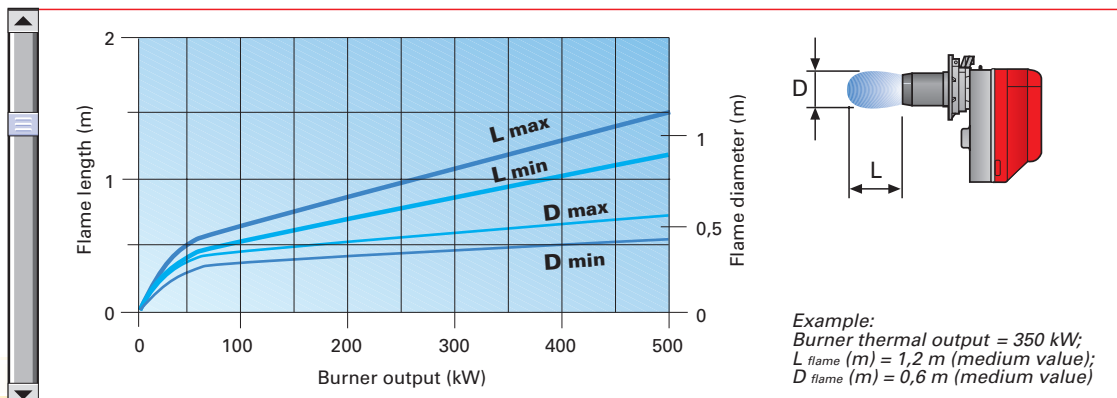



## ADJUSTMENT

### BURNER OPERATION MODE

All these models are one stage operation.

#### "One stage" operation

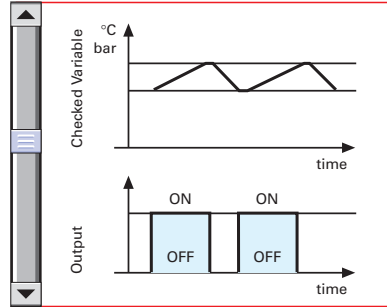

Air damper adjustment

All Gulliver BS series burners are fitted with a new microprocessor control panel for the supervision during intermittent operation.

For helping the commissioning and maintenance work, there are two main elements:



The lock-out reset button is the central **operating element** for resetting the burner control and for activating / deactivating the diagnostic functions.



The multi-color LED is the central **indication element** for visual diagnosis and interface diagnosis.

Both elements are located under the transparent cover of lock-out reset button, as showed below.

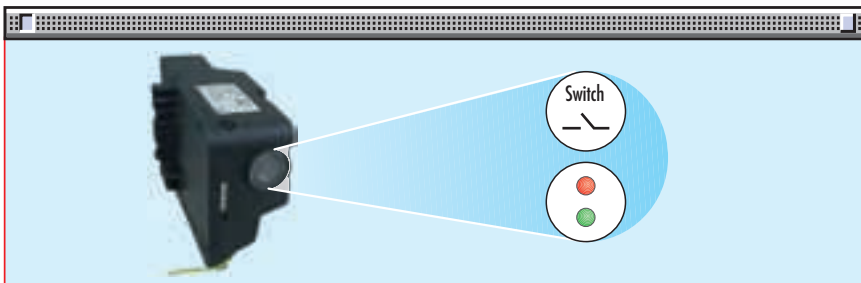

There are two diagnostic choices, for indication of operation and diagnosis of fault cause:

#### - visual diagnosis :

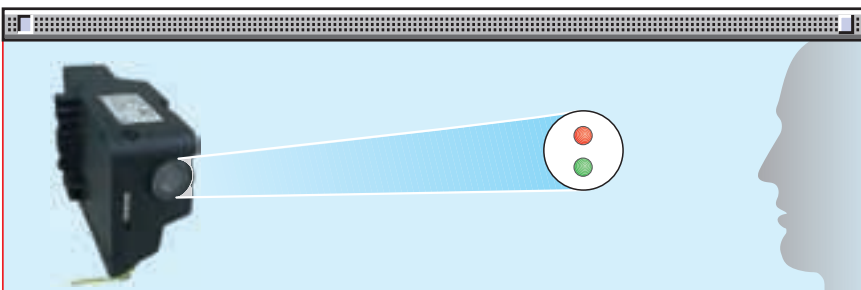

#### - interface diagnosis :

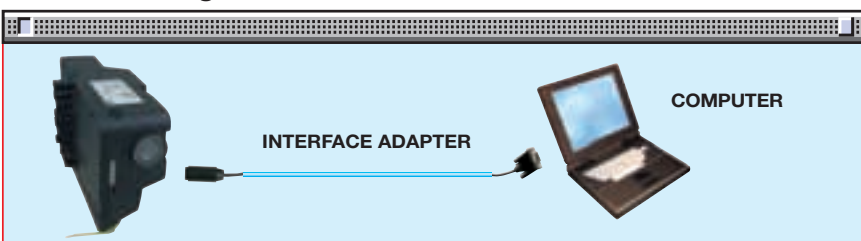

by the interface adapter and a PC with dedicated software.

**Indication of operation:**

In normal operation, the various statuses are indicated in the form of colour codes according to the table below.

Color code table	
Operation statuses	Color code
Stand-by	○ Led off
Pre-purging	● Green
Ignition phase	● Green
Flame OK	● Green
Post purge	● Green
Undervoltage, built-in fuse	○ Led off
Fault, alarm	● Red

**Diagnosis of fault causes:**

After lock-out has occurred, the red signal lamp is steady on. In this status, the visual fault diagnosis according to the error code table can be activated by pressing the lock-out reset button for > 3 seconds. The control box sends a sequence of pulses that are repeated at 2-second intervals.

The interface diagnosis (with adapter) can be activated by pressing again the lock-out button for > 3 seconds.

*Example of blinks sequence:*



Error code table	
Blink code	Possible cause of fault
2 blinks ● ●	No flame at the end of safety time: - faulty or soiled gas valves - faulty ionisation probe - poor adjustment of burner, no gas - faulty ignition - neutral / phase exchange
3 blinks ● ● ●	Air pressure switch does not close or is already closed before heat demand: - faulty air pressure switch - air pressure switch incorrectly regulated
4 blinks ● ● ● ●	Presence of flame: - in stand-by position - with thermostat of heat demand in idle or working position - during pre-purge - during post-purge
6 blinks ● ● ● ● ● ●	Loss of air pressure: - during pre-purge - during or after safety time
7 blinks ● ● ● ● ● ● ●	Loss of flame during operations after n°3 attempts of re-cycle: - faulty or soiled gas valves - faulty ionisation probe - short circuit between ionisation probe and earth of the burner - poor adjustment of burner, no fuel

The MG569 digital control box gives some other advantages:

**Post ignition (during safety time)**

The spark ignition is present during all safety time

**Adjustable post purge**

The Post-purge is a function that maintains air ventilation even after the burner is switched off.

Post-purge time can be set to a maximum of 6 minutes.

This function can be activated and set in a very easy way by pressing repeatedly the reset button; after 5 seconds the control box automatically shows the minutes set by the red LED flashing (1 pulse = post-ventilation for 1 minute).

If during post-purge there is a new request for heat, it is halted and a new operating cycle starts. The control box leaves the factory with the setting 0 minutes (no post-ventilation).

**Remote lock-out reset**

The 'Remote lock-out reset' is a function that allows to reset the control-box operation from a remote position. In the burner packages will be included a particular connector to remote the reset signal. The maximum length of connection must be 20 m.

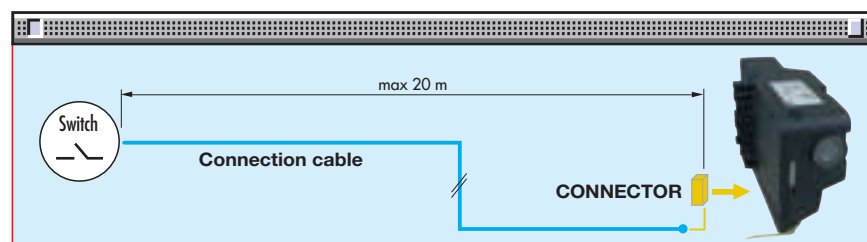



## START UP CYCLE

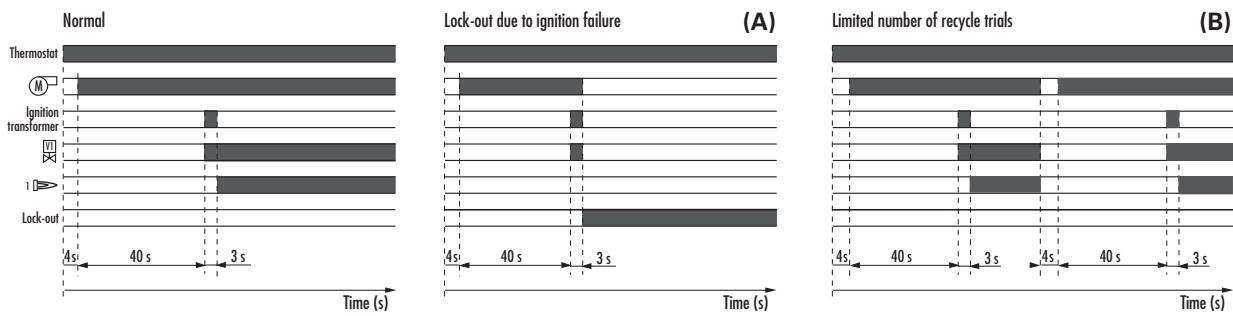

(A) Lock-out is shown by a led on the appliance.

(B) Total number of recycle trials is 3

### Correct operation

- 0s Start of heat demand the burner begins the ignition cycle
- 0s-4s The burner is in stand-by
- 4s-44s Pre-purge with opened air damper
- 44s Ignition.

### Lock-out due to ignition failure

If the flame does not light within the safety limit (~ 3s) the burner locks-out.

### Re-cycle

The burner permits maximum three repetitions of complete ignition cycle if there is flame failure during operation.

The burner goes in safety shut-down within one second.

The final action at the last trial following at last flame failure is a lock-out.



## WIRING DIAGRAMS

Electrical connections must be made by qualified and skilled personnel in conformity with the local regulations in force.



Control-box fitted with ignition transformer

## "ONE STAGE" OPERATION

### Burner electrical wiring

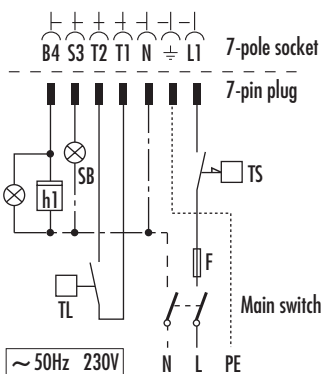

### Gas train electrical wiring

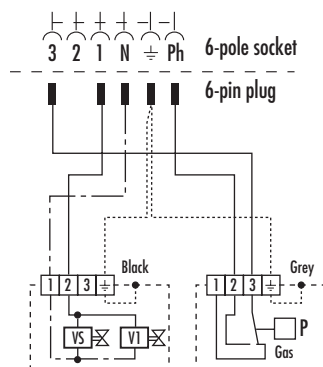

- h1** - One stage hours counter (230V 0,1A max)
- SB** - Remote lock-out signal (230V 0,1A max)
- TL** - Limit thermostat
- TS** - Safety thermostat (manual reset)
- VS** - Safety valve
- V1** - One stage valve
- P** - Gas pressure switch
- F** - Fuse

The following table shows the supply lead sections and types of fuse to be used.

Model	▼ BS1	▼ BS2	▼ BS3	▼ BS4
	230V	230V	230V	230V
F A	6	6	6	T6
L mm <sup>2</sup>	1	1	1	1

F = Fuse  
L = Lead section

## EMISSIONS



The burners in the Gulliver BS series guarantee controlled combustion, reducing emissions of both CO and NO<sub>x</sub>, this combustion control is due to the recirculation of the combustion products in the chamber (thanks to different combustible air flow speeds) and to the fuel staging technique (thanks to the special geometry of the gas nozzles).

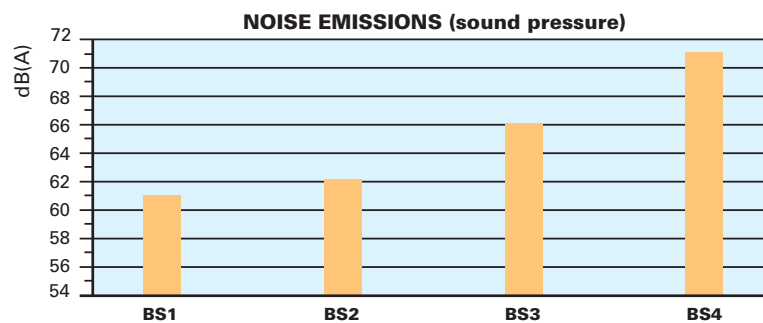
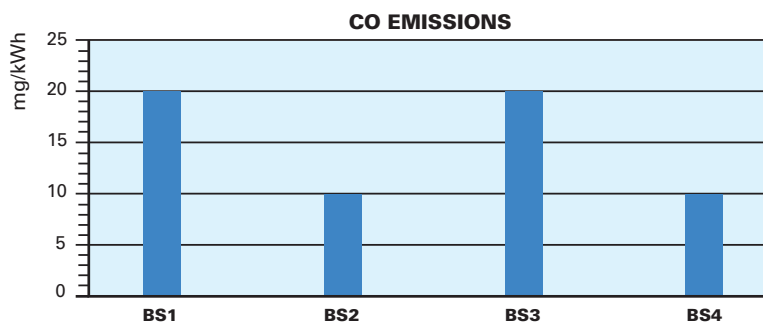
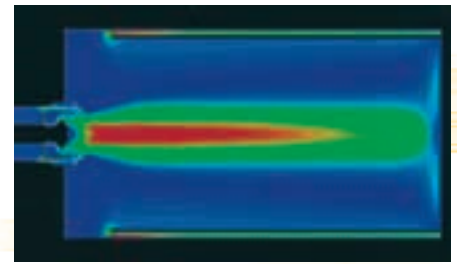
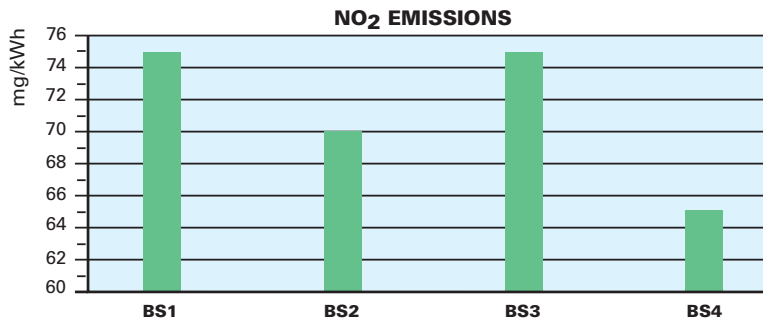

The emission data have been measured in the various models at maximum output, in conformity with EN 676 standard.

Special attention has been paid to noise reduction. All models are fitted with sound-proofing material inside the cover.





## OVERALL DIMENSIONS (mm)

These models are distinguished by their reduced size, in relation to the outputs achieved, which means they can be fitted to any boiler on the market.

### BURNER

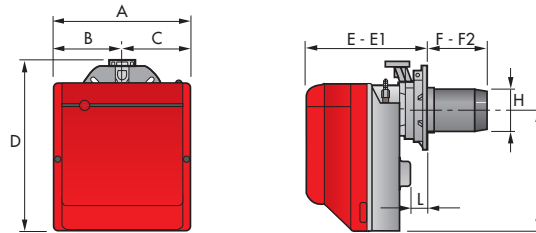

Model	A	B	C	D	E	E1	F	F2	H	I	L
▶ BS1	234	122	112	295	230	276	116	70	89	210	41
▶ BS2	255	125,5	125,5	325	238	252	114	100	106	230	45
▶ BS3	300	150	150	391	262	280	128	110	129	285	45
▶ BS4	300	150	150	392	271	301	168	145	137	286	45

### BURNER-BOILER MOUNTING FLANGE

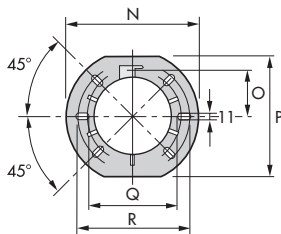

Model	N	O	P	Q	R
▶ BS1	192	66	167	140	170
▶ BS2	192	66	167	140	170
▶ BS3	216	76,5	201	160	190
▶ BS4	218	80,5	203	170	200

### PACKAGING

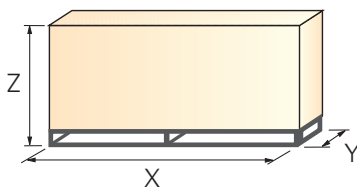

Model	X	Y	Z	kg
▶ BS1	385	268	340	10
▶ BS2	395	288	365	11
▶ BS3	440	335	430	15
▶ BS4	500	335	430	16,5

## INSTALLATION DESCRIPTION

Installation, start up and maintenance must be carried out by qualified and skilled personnel.

The burner is set in the factory on standard calibration (minimum output). If necessary adjustments can be made on the basis of the maximum output of the boiler. All operations must be performed as described in the technical handbook supplied with the burner.

- ▶ The mobile flange allows adapting the length of the combustion head to the combustion chamber (flame inversion or 3 smoke cycles) and to the thickness of the boiler panel.



### BURNER SETTING

- ▶ The air damper position can be adjusted without removing the burner cover.
- ▶ Head setting is easy and aided by a graduated scale; a test point allows reading the air pressure in the combustion head.
- ▶ Gulliver BS burners are fitted with an air pressure switch which, in accordance with EN 676 standards, can be adjusted by the installer using a graduated selector, on the basis of the effective working conditions.



### MAINTENANCE AND ELECTRICAL CONNECTIONS

- ▶ Maintenance is easily solved because the combustion head can be disassembled without having to remove the burner and gas train from the boiler.



- ▶ The 7-pole socket is incorporated in the control box, the 6-pole socket for connection to the gas train is already connected to the equipment and fixed to the outside of the burner.
- The 7-pin plug is also supplied for connection to the boiler.

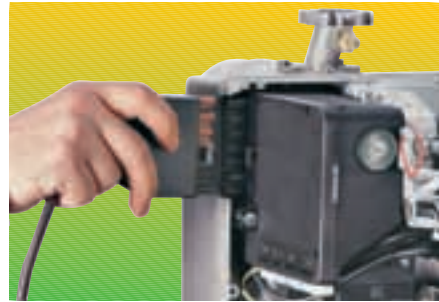

## BURNER ACCESSORIES

### Extended head kit

Standard head" burners can be transformed into "extended head" versions by using the special kit. Below the KITS available for the various burners are listed, showing the original and the extended lengths.

Extended head kit			
Burner	Standard head length (mm)	Extended head length (mm)	Kit code
BS2 (long)	100 ÷ 114	170 ÷ 180	<b>3001007</b>
BS2 (extra long)	100 ÷ 114	270 ÷ 280	<b>3001008</b>
BS3	110 ÷ 128	267 ÷ 282	<b>3001009</b>
BS4	145 ÷ 168	302 ÷ 317	<b>3001016</b>

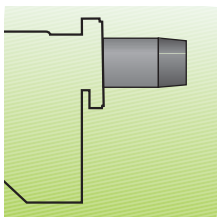

### LPG kit

For burning LPG gas, a special kit is available to be fitted to the combustion head on the burner, as shown in the following table:



LPG kit		
Burner	Kit code for standard head	Kit code for extended head
BS1	<b>3001003</b>	-
BS2	<b>3001004</b>	<b>3001004</b>
BS3	<b>3001005</b>	<b>3001005</b>
BS4	<b>3001011</b>	<b>3001011</b>



### Alternative combustion head kit

To extend the adaptability of Gulliver BS burners to any sort of application, alternative combustion heads have been developed, for example, to overcome situations of combustion instability which could arise with certain heat generators. These heads cause a very limited increase in NOx emissions, due to the slower air flow.

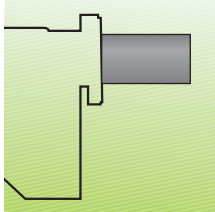

Alternative combustion head kit	
Burner	Kit code
BS1	3001059
BS2	3001064
BS3	3001060
BS4	3001070

### Ground fault interrupter kit

A "Ground fault interrupter kit" is available as a safety device in case of electrical system fault. It is supplied with burners with pin plug.



Ground fault interrupter kit	
Burner	Kit code
BS1 - BS2 - BS3 - BS4	3001180

### Multibloc rotation kit

There is a special kit available that can be used to install the burner turned 180°. This kit is designed to ensure the gas train valve properly.

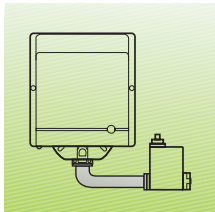

Multibloc rotation kit	
Burner	Kit code
BS1	3001179
BS2	3001177
BS3 - BS4	3001178

### 7-pin plug kit

If necessary a 7-pin plug kit is available (in packaging of n. 5 pieces).

7-pin plug kit	
Burner	Kit code
BS1 - BS2 - BS3 - BS4	3000945

### Interface adapter kit

To connect the flame control panel to a personal computer for the transmission of operation, fault signals and detailed service information, an interface adapter with PC software are available.



Interface adapter kit	
Burner	Kit code
BS1 - BS2 - BS3 - BS4	3002731



## GAS TRAIN ACCESSORIES

### Seal control kit

To test the valve seals on the gas train, (except for the model with Multibloc MBC 65 DLE) a special "seal control kit" is available.



Seal control kit		
Burner	Gas Train	Kit code
BS1	MBDLE 403 - 405	3010123
BS2	MBDLE 405 - 407	3010123
BS3	MBDLE 407 - 410 - 412	3010123
BS4	MBDLE 407 - 410 - 412	3010123



## SPECIFICATION

A special index guides your choice of boiler from the various models available in the BS series. Below there is a clear and detailed specification description of the product.

### DESIGNATION OF SERIES

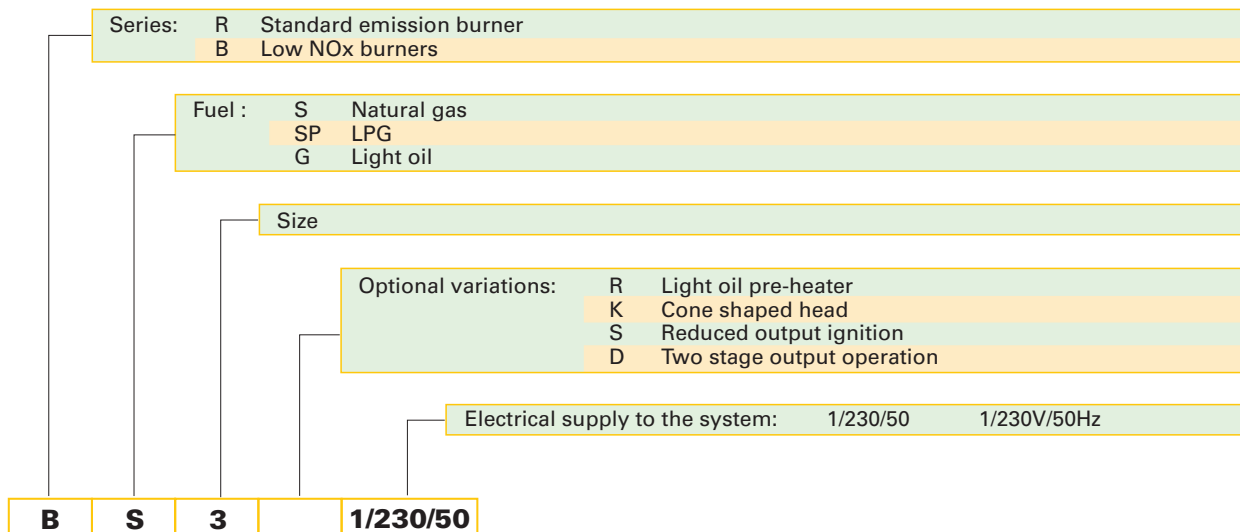

### AVAILABLE BURNER MODELS

BS1	1/230/50
BS2	1/230/50
BS3	1/230/50
BS4	1/230/50

## PRODUCT SPECIFICATION

### **Burner:**

Monoblock, gas burners, completely automatic, one stage operation, made up of:

- Fan with forward curve blades
- Cover lined with sound-proofing material
- Air damper, completely closed in stand by, with external adjustment, with no need to remove the cover
- Single phase electric motor 230 V, 50 Hz
- Combustion head fitted with:
  - stainless steel head cone, resistant to high temperatures
  - ignition electrodes
  - ionisation probe
  - gas distributor
  - flame stability disk
- Flame inspection window
- Adjustable air pressure switch, with graduated selector, to guarantee burner lock out in the case of insufficient combustible air
- Microprocessor-based flame control panel, with diagnostic and remote reset functions
- Protection filter against radio interference (included into flame control panel)
- IP X0D (IP 40) electric protection level.

### **Gas train:**

Fuel supply line in the Multibloc configuration, fitted with:

- Filter
- Pressure stabiliser
- Minimum gas pressure switch
- Safety valve
- Single stage working valve with ignition gas output regulator.

### **Approval:**

- EN 676 standard
- LRV 92 standard.

### **Conforming to European Directives:**

- 90/396/EEC (gas)
- 73/23/EEC (low voltage)
- 89/336/EEC (electromagnetic compatibility)
- 92/42/EEC (efficiency).

### **Conforming to:**

- BImSchV 1996.

### **Standard equipment:**

- Sliding flange
- Flange insulation screen
- Screws and nuts for fixing the flange to the boiler
- 7-pin plug
- Remote control release kit
- Instruction handbook for installation, use and maintenance
- Spare parts catalogue.

### **Available accessories to be ordered separately:**

- Extended head kit
- LPG kit
- Alternative combustion head kit
- Ground fault interrupter kit
- Multibloc rotation kit
- 7-pin plug kit
- Interface adapter kit
- Seal control kit.



RIELLO S.p.A. - Via Ing. Pilade Riello, 5 - 37048 San Pietro di Legnago (VR) Italy  
Tel. ++39.0442630111 - Fax ++39.044221980

Internet: <http://www.rielloburners.com> - E-mail: [info@rielloburners.com](mailto:info@rielloburners.com)

Since the Company is constantly engaged in the production improvement, the aesthetic and dimensional features, the technical data, the equipment and the accessories can be changed.  
This document contains confidential and proprietary information of RIELLO S.p.A.  
Unless authorised, this information shall not be divulged, nor duplicated in whole or in part.

