



CE

TWO STAGE GAS BURNERS

▶ **RIELLO 40 GSD SERIES**

▶ **GS10D** 29/41 ÷ 106 kW

▶ **GS20D** 58/81 ÷ 220 kW

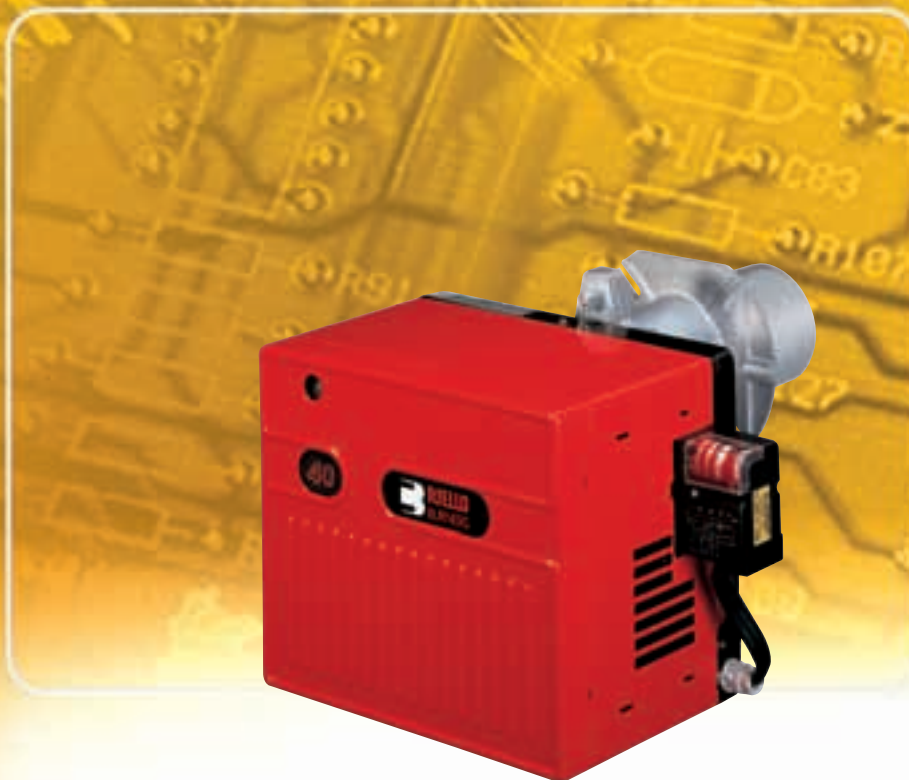

The Riello 40 GSD series of two stage gas burners, is a complete range of products developed to respond to any request for home heating. The Riello 40 GSD series is available in two different models, with an output ranging from 29 to 220 kW, divided in two different structures.

All the models use the same components designed by Riello for the Riello 40 GSD series. The high quality level guarantees safe working.

In developing these burners, special attention was paid to reducing noise, to the ease of installation and adjustment, to obtaining the smallest size possible to fit into any sort of boiler available on the market.

All the models are approved by the EN 676 European Standard and conform to European Directives for EMC, Low Voltage, Machinery and Boiler Efficiency.

All the Riello 40 GSD burners are tested before leaving the factory.

TECHNICAL DATA

Model		▼ GS10D	▼ GS20D	
Burner operation mode		Two stage		
Modulation ratio at max. output		--		
Servomotor	type	BERGER		
	run time	13		
Heat output	kW	29/41 - 106	58/81 - 220	
	Mcal/h	25/35 - 91	50/70 - 189	
Working temperature	°C min./max.	0 /40		
Fuel / air data	Net calorific value G20 gas	kWh/Nm ³ 10		
	G20 gas density	kg/Nm ³ 0,71		
	G20 gas delivery	2,9/4,1 - 10,6	5,8/8,1 - 22	
	Net calorific value G25 gas	kWh/Nm ³ 8,6		
	G25 gas density	kg/Nm ³ 0,78		
	G25 gas delivery	3,4/4,8 - 12,3	6,7-9,4 - 25,6	
	Net calorific value LPG gas	kWh/Nm ³ 25,8		
	LPG gas density	kg/Nm ³ 2,02		
	LPG gas delivery	1,1/1,6 - 4,1	2,2/3,1 - 8,5	
	Fan	type Centrifugal with forward curve blades		
	Air temperature	Max. °C 40		
	Electrical data	Electrical supply	Ph/Hz/V 1/50/230 ±10%	
Auxiliary electrical supply		Ph/Hz/V --		
Control box		type RMG 88.620A2		
Total electrical power		0,130	0,250	
Auxiliary electrical power		kW --		
Protection level		IP 40		
Motor electrical power		0,09	0,15	
Rated motor current		0,7	1,4	
Motor start up current		2,8	5,6	
Motor protection level		IP 20		
Ignition transformer		type	Separated from the control box	
		V1 - V2	230 V - 8 kV	
	I1 - I2	1,8 A - 30 mA		
Operation	Intermittent (at least one stop every 24 h)			
Emissions	Sound pressure	65	72	
	Sound power	W --		
	CO emission	mg/kWh <40		
	NOx emission	mg/kWh ≤120		
Approval	Directive	90/396/EEC, 89/336/EEC, 73/23/EEC, 98/37/EEC, 92/42/EEC		
	Conforming to	EN 676		
	Certification	CE - 0063 AP6680		

Reference conditions:

Temperature: 20 °C

Pressure: 1013,5 mbar

Altitude: 100 m a.s.l.

Noise measured at a distance of 1 meter.

Since the Company is constantly engaged in the production improvement, the aesthetic and dimensional features, the technical data, the equipment and the accessories can be changed.

This document contains confidential and proprietary information of RIELLO S.p.A. Unless authorised, this information shall not be divulged, nor duplicated in whole or in part.

FIRING RATES

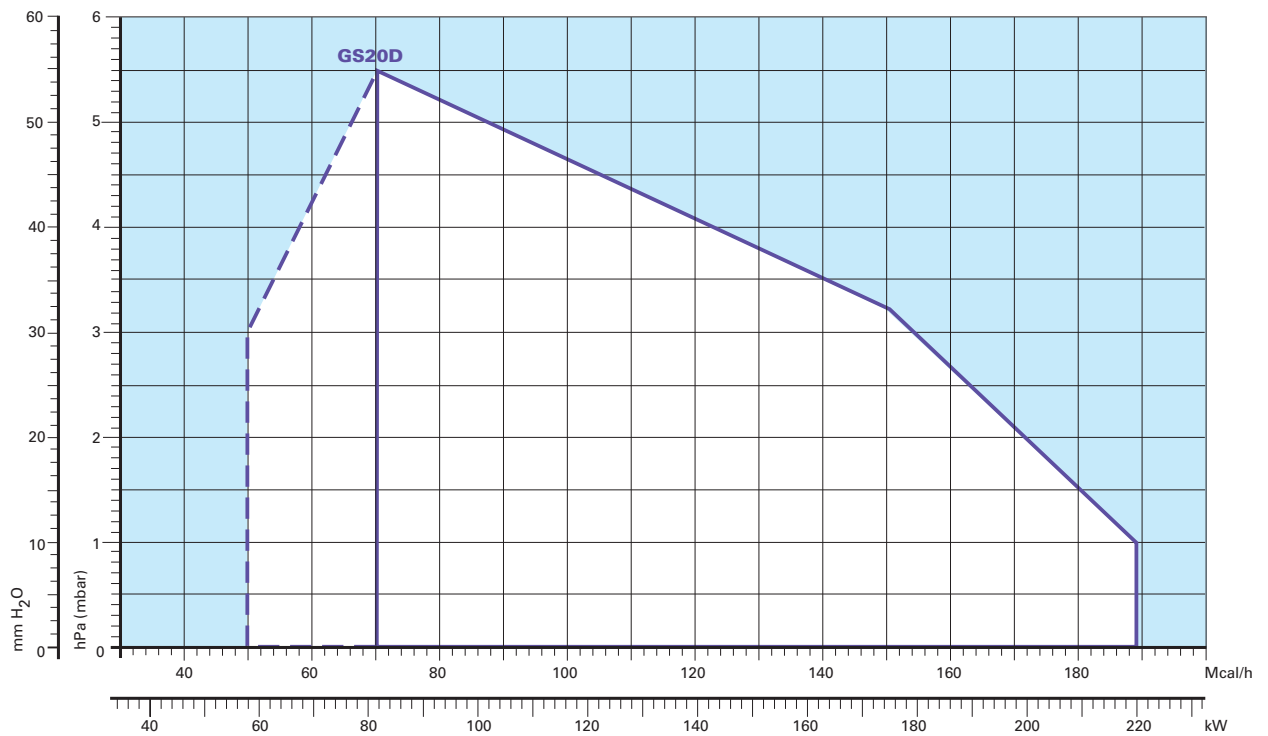
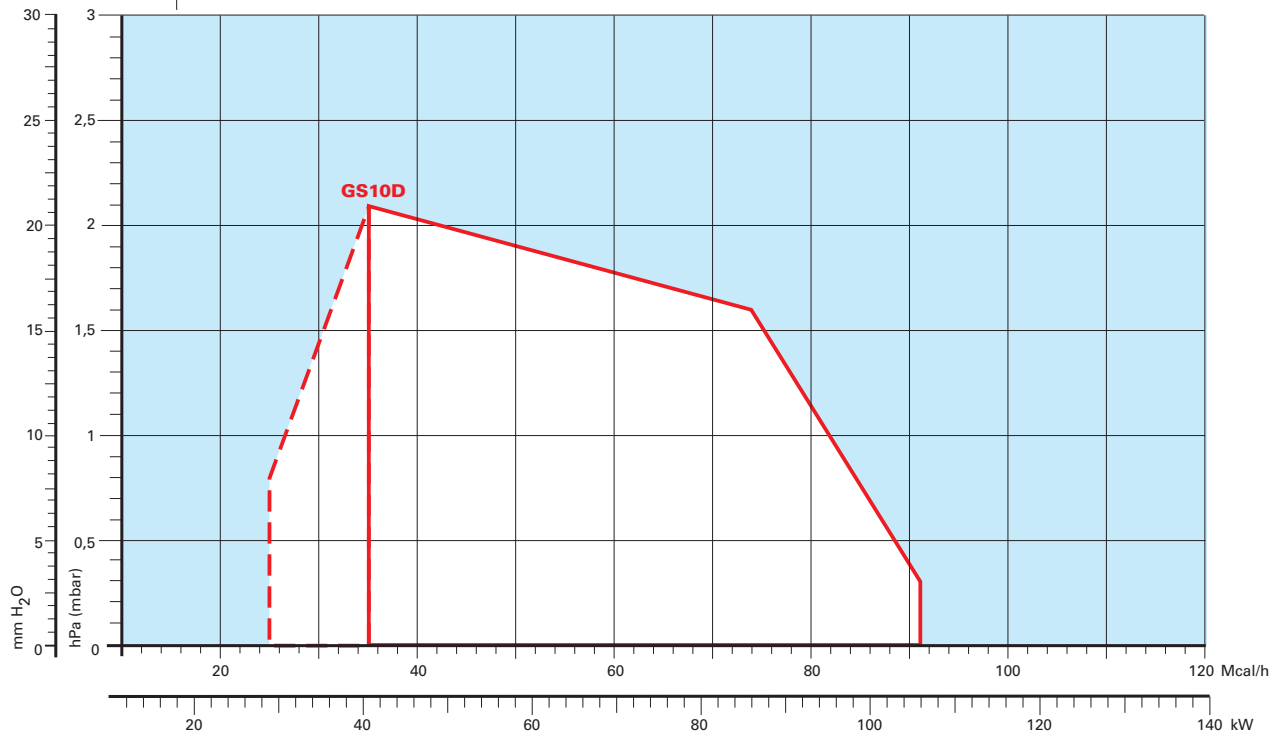

Useful working field for choosing the burner

1st stage operating rate

Test conditions conforming to EN 676 standards:

Temperature: 20 °C
 Pressure: 1013.5 mbar
 Altitude: 100 m a.s.l.





FUEL SUPPLY

GASTRAIN

The burners are set for fuel supply from either the right or left hand sides.

Depending on the gas output and the available pressure in the supply line, you should check the correct gas train to be adapted to the system requirements.

The gas train is Multibloc type, containing the main components in a single unit and it can be fitted with the valves seal control (as accessory).



MBZRDLE 405 - 407 - 410

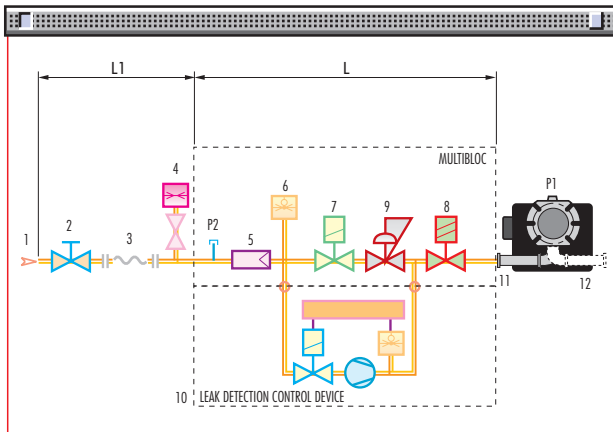

1	Gas delivery pipe
2	Manual valve
3	Vibration damping joint
4	Gas pressure gauge
5	Filter
6	Gas pressure switch
7	Safety solenoid
8	Adjustment solenoid 1st and 2nd stage: firing delivery adjustment (rapid opening) maximum delivery adjustment (slow opening)
9	Pressure regulator
10	Leak detection control device for valves 7 and 8 (accessory)
11	Gas train-burner adapter
12	Burner
P1	Combustion head pressure
P2	Upstream pressure from the filter
L	Gas train supplied separately
L1	To be performed by the installer

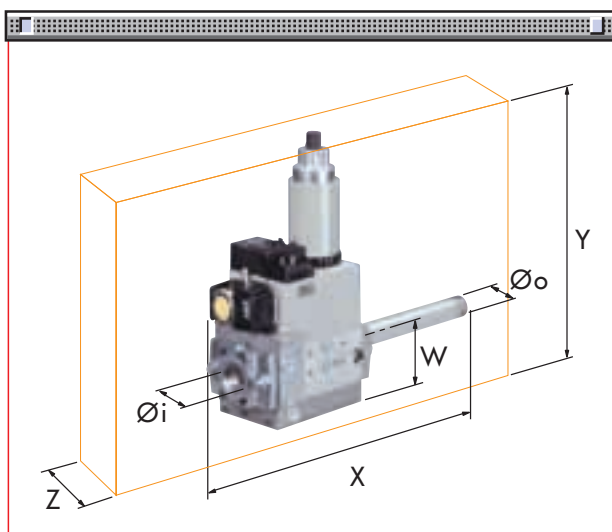

The dimensions of the gas trains vary depending on their construction features. The following table shows the dimensions of the gas trains that can be fitted to Riello 40 GSD burners, intake and outlet diameters.

	Name	Code	Ø i	Ø o	X mm	Y mm	W mm	Z mm
MULTIBLOC	MBZRDLE 405	3970084	Rp 1/2"	Rp 1/2"(*)	321	257	46	120
	MBZRDLE 407	3970537	Rp 3/4"	Rp 3/4"	371	257	46	120
	MBZRDLE 410	3970534	1"	Rp 3/4"	405	315	55	145

(*) With 1/2" - 3/4" reduction nipple supplied.



► PRESSURE DROP DIAGRAM

The diagrams indicate the minimum pressure drop of the burners with the various gas trains that can be combined with them; the value thus calculated represents the minimum required input pressure to the gas train.

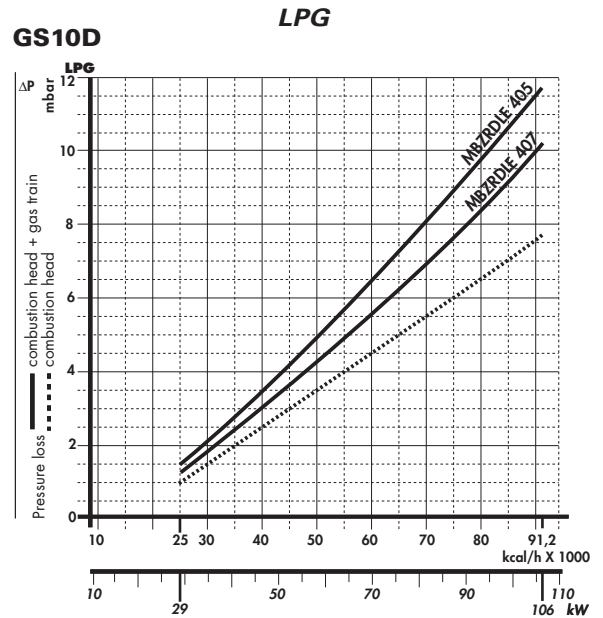
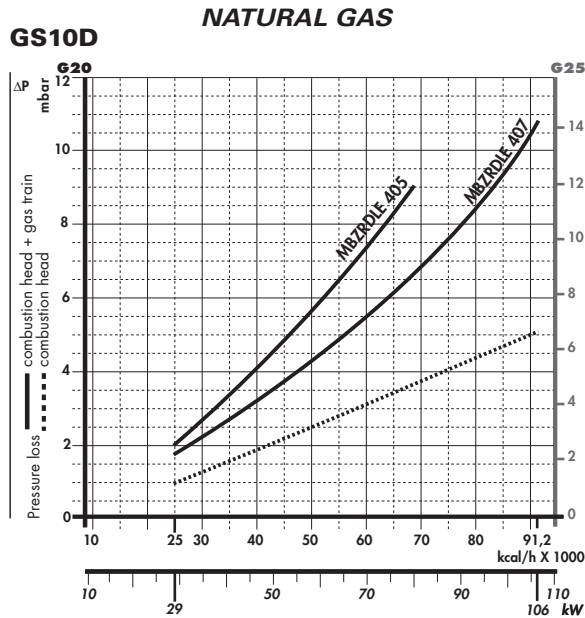

Gas train	Code	Output kW	Plug and socket
MBZRDLE 405	3970084	≤ 80 (*)	•
MBZRDLE 407	3970537	-	•

(*) With natural gas.

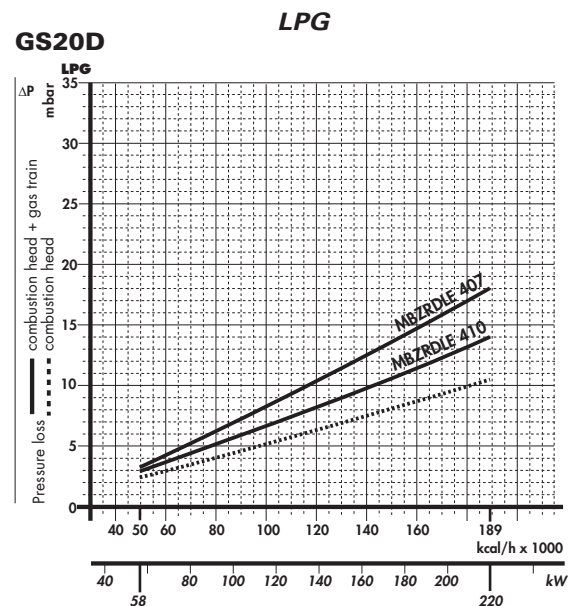
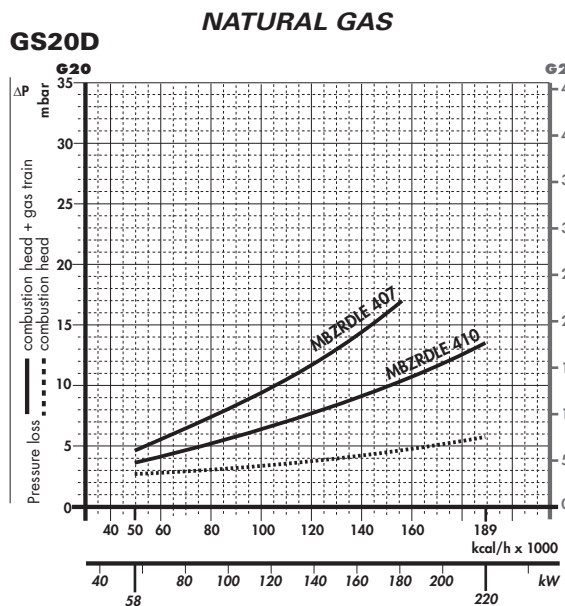

Gas train	Code	Output kW	Plug and socket
MBZRDLE 407	3970537	≤ 180 (*)	•
MBZRDLE 410	3970534	-	•

(*) With natural gas.

► **note** For pressure levels different from those indicated above, please contact Riello Burners Technical Office.
 In LPG plants, Multibloc gas trains do not operate below 0°C.
 They are only suitable for gaseous LPG (liquid hydrocarbons destroy the seal materials).





SELECTING THE FUEL SUPPLY LINES

The following diagram enables pressure drop in a pre-existing gas line to be calculated and to select the correct gas train.

The diagram can also be used to select a new gas line when fuel output and pipe length are known. The pipe diameter is selected on the basis of the desired pressure drop. The diagram uses methane gas as reference; if another gas is used, conversion coefficient and a simple formula (on the diagram) transform the gas output to a methane equivalent (refer to figure A). Please note that the gas train dimensions must take into account the back pressure of the combustion chamber during operations.

Control of the pressure drop in an existing gas line or selecting a new gas supply line.

The methane output equivalent is determined by the formula fig. A on the diagram and the conversion coefficient.

Once the equivalent output has been determined on the delivery scale (\dot{V}), shown at the top of the diagram, move vertically downwards until you cross the line that represents the pipe diameter; at this point, move horizontally to the left until you meet the line that represents the pipe length.

Once this point is established you can verify, by moving vertically downwards, the pipe pressure drop of on the bottom scale below (mbar).

By subtracting this value from the pressure measured on the gas meter, the correct pressure value will be found for the choice of gas train.

- Example:**
- gas used G25
 - gas output 9.51 mc/h
 - pressure at the gas meter 20 mbar
 - gas line length 15 m
 - conversion coefficient 0.62 (see figure A)

- equivalent methane output $\dot{V} = \left[\frac{9.51}{0.62} \right] = 15.34 \text{ mc/h}$

- once the value of 15.34 has been identified on the output scale (\dot{V}), moving vertically downwards you cross the line that represents 1" 1/4 (the chosen diameter for the piping);
- from this point, move horizontally to the left until you meet the line that represents the length of 15 m of the piping;
- move vertically downwards to determine a value of 1.4 mbar in the pressure drop bottom scale;
- subtract the determined pressure drop from the meter pressure, the correct pressure level will be found for the choice of gas train;
- correct pressure = (20-1.4) = 18.6 mbar

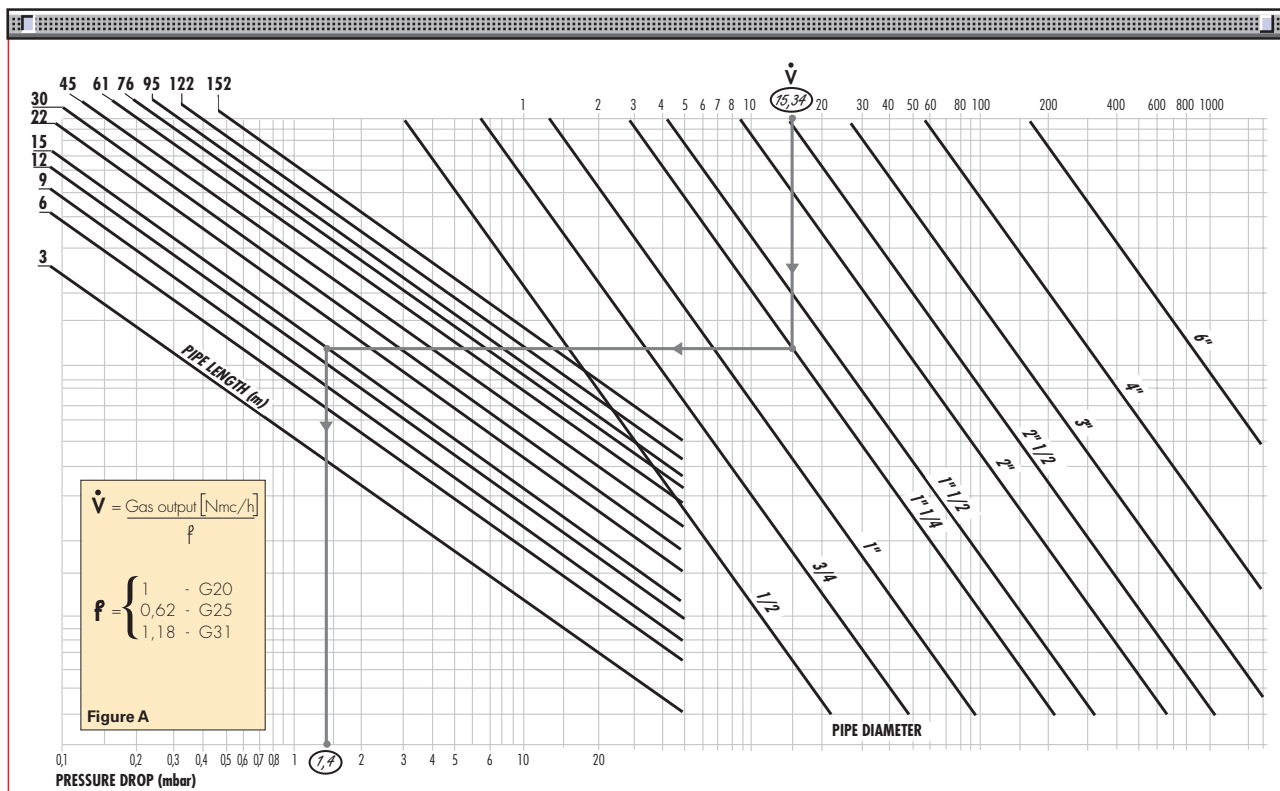

VENTILATION

The different ventilation circuits always ensure low noise levels with high performance of pressure and air delivery, inspite of their compact size.
The burners are fitted with an adjustable air pressure switch, conforming to EN 676 standards.



Air suction



Air pressure switch

COMBUSTION HEAD

The combustion head in Riello 40 GSD burners is the result of an innovative design, which allows combustion with low polluting emissions, while being easy to adapt to all the various types of boilers and combustion chambers.

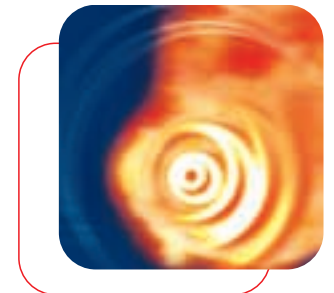

Combustion head



Flange

Simple adjustment allows the internal geometry of the combustion head to be adapted to the burner output.

Dimensions of the flame

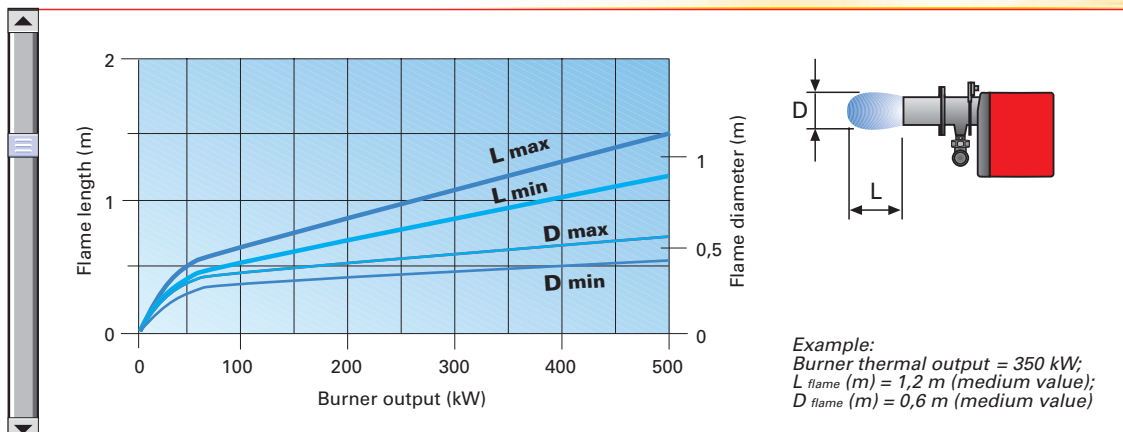



ADJUSTMENT

► BURNER OPERATION MODE

All these models are two stage operation. The Riello 40 GSD series

of two stage burners allows operating at both full and reduced output, with consequent reduction in turning the burner on and off, their giving better performance to the boiler.

During stand-by, the air damper is completely closed (controlled by an electric servomotor) and prevents heat loss due to the flue draught.

Two stage operation

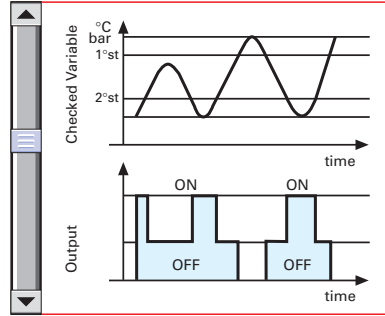

Air damper adjustment

This series burners are fitted with a new microprocessor control panel for the supervision during intermittent operation.

For helping the commissioning and maintenance work, there are two main elements:



The lock-out reset button is the central **operating element** for resetting the burner control and for activating / deactivating the diagnostic functions.



The multi-color LED is the central **indication element** for visual diagnosis and interface diagnosis.

Both elements are located under the transparent cover of lock-out reset button, as showed below.

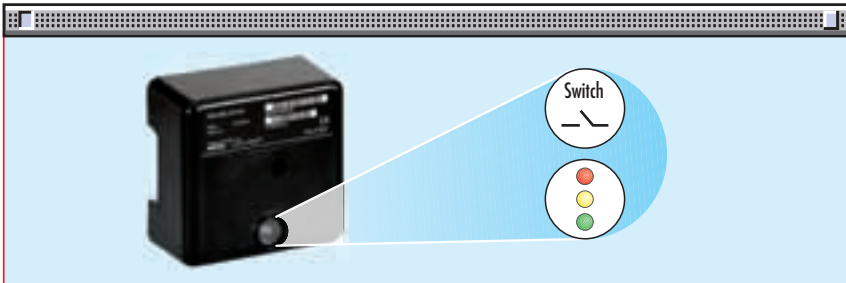

There are two diagnostic choices, for indication of operation and diagnosis of fault cause:

- visual diagnosis :

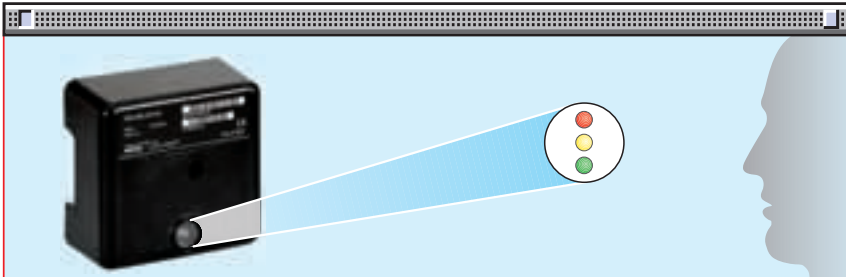

- interface diagnosis :



by the interface adapter and a PC with dedicated software or by a predisposed flue gas analyzer (see paragraph accessories).



Indication of operation :

In normal operation, the various statues are indicated in the form of colour codes according to the table below.

The interface diagnosis (with adapter) can be activated by pressing the lock-out button for > 3 seconds.

Color code table	
Operation statuses	Color code table
Stand-by	○ ○ ○ ○ ○ ○ ○ ○ ○
Pre-purging	☀ ☀ ☀ ☀ ☀ ☀ ☀ ☀ ☀
Ignition phase	☀ ○ ☀ ○ ☀ ○ ☀ ○
Flame OK	☘ ☘ ☘ ☘ ☘ ☘ ☘ ☘ ☘
Poor flame	☘ ○ ☘ ○ ☘ ○ ☘ ○
Undervoltage, built-in fuse	☀ ☀ ☀ ☀ ☀ ☀ ☀ ☀ ☀
Fault, alarm	☘ ☘ ☘ ☘ ☘ ☘ ☘ ☘ ☘
Extraneous light	☘ ☘ ☘ ☘ ☘ ☘ ☘ ☘ ☘

○ LED off

Diagnosis of fault causes :

After lock-out has occurred, the red signal lamp is steady on. In this status, the visual fault diagnosis according to the error code table can be activated by pressing the lock-out reset button for > 3 seconds. The interface diagnosis (with adapter) can be activated by pressing again the lock-out button for > 3 seconds.

The blinkers of red LED are a signal with this sequence :

(e.g. signal with n° 3 blinks – faulty air pressure monitor)



Error code table	
Possible cause of fault	Blink code
No establishment of flame at the end of safety time : - faulty or soiled fuel valves - faulty or soiled flame detector - poor adjustment of burner, no fuel - faulty ignition equipment	☘ ☘
Faulty air pressure monitor	☘ ☘ ☘
Simulation of flame on burner start up	☘ ☘ ☘ ☘
Loss of flame during operation : - faulty or soiled fuel valves - faulty or soiled flame detector - poor adjustment of burner	☘ ☘ ☘ ☘ ☘ ☘ ☘ ☘
Wiring error or internal fault	☘ ☘ ☘ ☘ ☘ ☘ ☘ ☘ ☘ ☘ ☘ ☘

START UP CYCLE

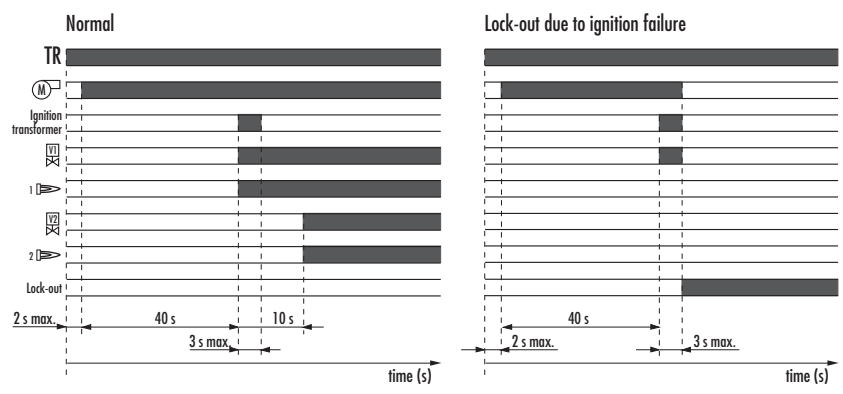

Correct operation

- 0s The burner begins the ignition cycle
- 0s-2s Safety time
- 2s-42s Pre-purge with opened air damper
- 42s-45s Ignition 1st stage
- 52s Ignition 2nd stage.

Lock-out

If the 1st stage flame does not light within the safety limit (3s max.) the burner locks-out. When flame-failure occurs during working, shut down takes place within one second.



WIRING DIAGRAMS

Electrical connections must be made by qualified and skilled personnel in conformity with the local regulations in force.

The 7-pole socket, the 4-pole socket (for connecting the 2nd stage thermostat and the hour meter) and the 6-pole socket (for connection to the gas train) are connected to the equipment and fixed into the burner. The 7 and 4-pin plugs are supplied for connection to the boiler.



Appliance fitted with 7-pole, 6-pole and 4-pole sockets

TWO STAGE OPERATION

GS10D - GS20D

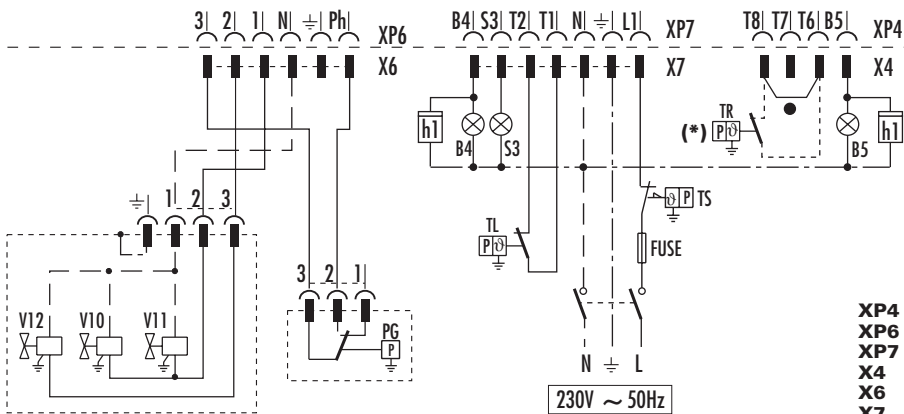

Electrical wiring with gas leak control device (DUNGS VPS 504)

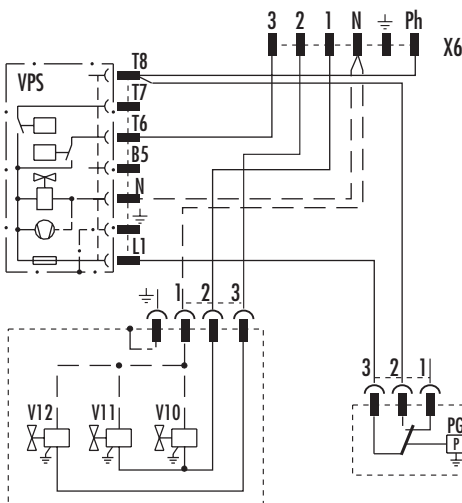

- XP4** - 4 pole socket
- XP6** - 6 pole socket
- XP7** - 7 pole socket
- X4** - 4 pin plug
- X6** - 6 pin plug
- X7** - 7 pin plug
- B4** - 1st stage working signal
- B5** - 2nd stage working signal
- h1** - 1st stage hour counter
- h2** - 2nd stage hour counter
- PG** - Minimum gas pressure switch (230V - 0,5A max.)
- S3** - Remote lock-out signal (230V - 0,5A max.)
- TL** - Limit thermostat
- TR** - 2nd stage thermostat
- TS** - Safety thermostat
- V10** - Safety valve
- V11** - 1st stage valve
- V12** - 2nd stage valve

(*) Connect 2nd stage thermostat between clamps T6 and T8 removing the bridge.

The following table shows the supply lead sections and types of fuse to be used.

Model	▼ GS10D	▼ GS20D
	230V	230V
F A	T6	T6
L mm ²	1	1

F = Fuse

L = Lead section

EMISSIONS

The emission data have been measured in the various models at maximum output, in conformity with EN 676 standard.

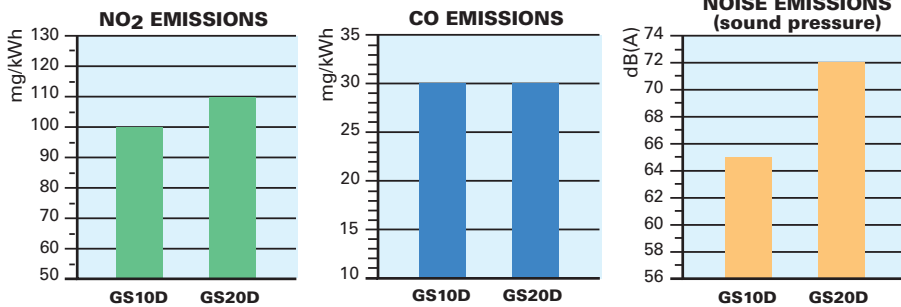

Special attention has been paid to noise reduction. All models are fitted with sound-proofing material inside the cover.

OVERALL DIMENSIONS (mm)

These models are distinguished by their reduced size, in relation to the outputs achieved, which means they can be fitted to any boiler actually on the market.

BURNER

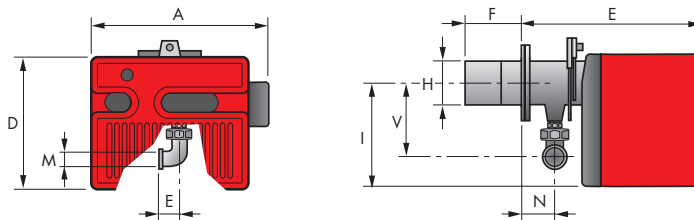

Model	A	D	E	F	H	I	M	N	V	Z
▶ GS10D	368	262	346	110	105	204	Rp 3/4"	61	142	33
▶ GS20D	413	298	389	120	125	230	Rp 3/4"	67	152	33

BURNER-BOILER MOUNTING FLANGE

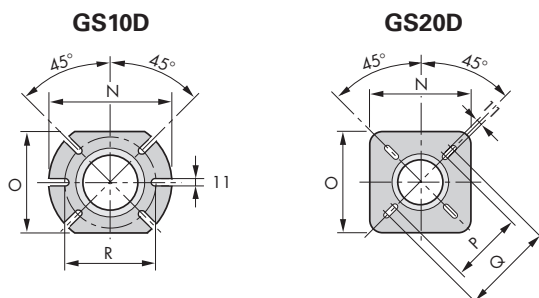

Model	N	O	P	Q	R
▶ GS10D	185	160	-	-	130
▶ GS20D	170	170	155	200	-

PACKAGING

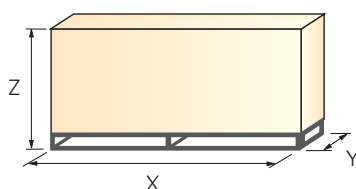

Model	X	Y	Z	kg
▶ GS10D	485	473	320	17
▶ GS20D	525	525	365	22



INSTALLATION DESCRIPTION

Installation, start up and maintenance must be carried out by qualified and skilled personnel. All operations must be performed as described in the technical handbook supplied with the burner. The burner is set in the factory on standard calibration (minimum output). If necessary adjustments can be made on the basis of the maximum output of the boiler.

BURNER SETTING

- ▶ The air damper position can be adjusted without removing the burner cover.
- ▶ Head setting is easy and aided by a graduated scale; a test point allows reading the air pressure in the combustion head.
- ▶ Riello 40 GSD burners are fitted with an air pressure switch which, in accordance with EN 676 standards, can be adjusted by the installer using a graduated selector, on the basis of the effective working conditions.

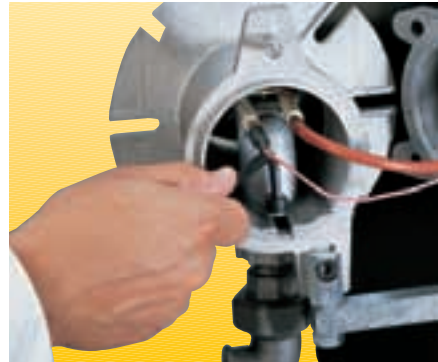

MAINTENANCE

- ▶ The maintenance position is easily carried out by hinge that joins the body of burner to the flange.

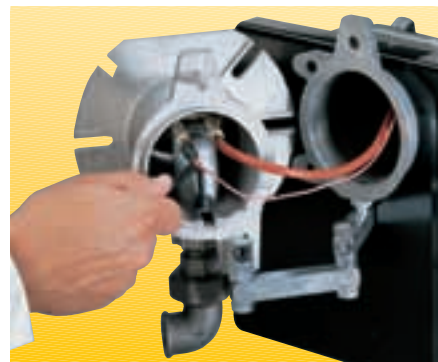

BURNER ACCESSORIES

Extended head kit

"Standard head" burners can be transformed into "extended head" versions by using the special kit. Below the KITS available for the various burners are listed, showing the original and the extended lengths.

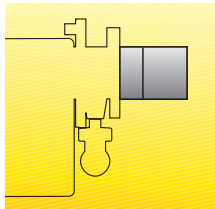

Extended head kit			
Burner	Standard head length (mm)	Extended head length (mm)	Kit code
GS10D	110	170	3000864
GS20D	120	280	3000873



End cone with turbulator disk

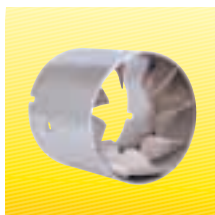

End cone with turbulator disk		
Burner	Projection (mm)	Code
GS10D	+18	3000918
GS20D	+23	3000919

Town gas kit

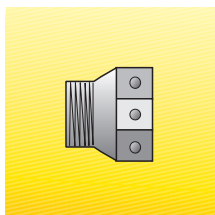

Town gas transformation kit	
Burner	Kit code
GS10D	3000891
GS20D	3000893

LPG kit

For burning LPG gas, a special kit is available to be fitted to the combustion head on the burner, as shown in the following table:



LPG kit		
Burner	Kit code for standard head	Kit code for extended head
GS10D	3000884	3000884
GS20D	3000886	3000886

Interface adapter kit

To connect the flame control panel to a personal computer for the transmission of operation, fault signals and detailed service information, an interface adapter with PC software are available.



Interface adapter	
Burner	Kit code
GS10D - GS20D	3002719

7-pin plug kit

If necessary a 7-pin plug kit is available (in packaging of n. 5 pieces).

7-pin plug kit	
Burner	Kit code
GS10D - GS20D	3000945

Ground fault interrupter kit

A "Ground fault interrupter kit" is available as a safety device in case of electrical system fault. It is supplied with burners with pin plug.



Ground fault interrupter kit	
Burner	Kit code
GS10D - GS20D	3001180

Continuous ventilation kit for RMG control box

If the burner requires continuous ventilation in the stages without flame, a special kit is available as given in the following table.

Continuous ventilation kit for RMG control box	
Burner	Kit code
GS10D - GS20D	3010094

GAS TRAIN ACCESSORIES

Seal control kit

To test the valve seals on the gas train, a special "seal control kit" is available.



Seal control kit	
Burner	Kit code
GS10D - GS20D	3010123

SPECIFICATION

A special index guides your choice of boiler from the various models available in the Riello 40 GSD series. Below is a clear and detailed specification description of the product.

DESIGNATION OF SERIES

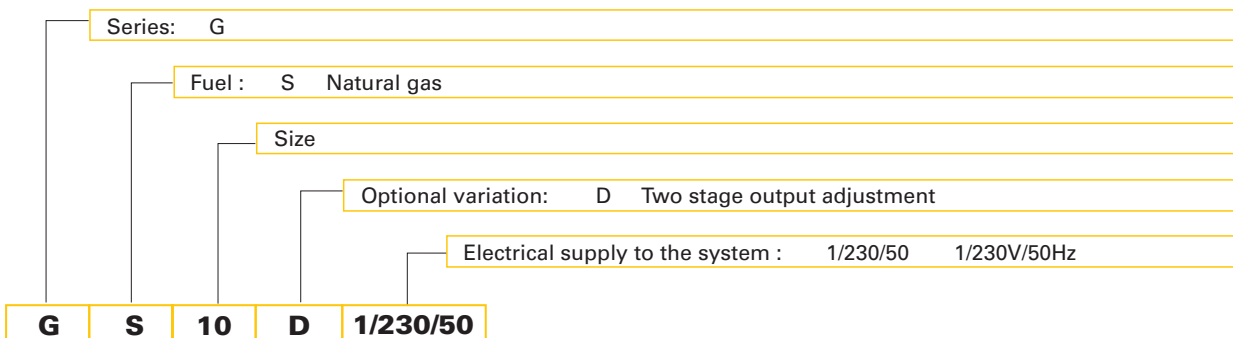



▶ AVAILABLE BURNER MODELS

GS10D	1/230/50
GS20D	1/230/50

▶ PRODUCT SPECIFICATION

Burner

Monoblock, gas burners, completely automatic, with two stage settings fitted with:

- Fan with forward curve blades
- Cover lined with sound-proofing material
- Air damper, completely closed in stand by, driven by an electric servomotor
- Air damper with 1st and 2nd stage adjustment
- Single phase electric motor 230 V, 50 Hz
- Combustion head fitted with:
 - stainless steel head cone, resistant to high temperatures
 - ignition electrodes
 - ionisation probe
 - gas distributor
 - flame stability disk
- Adjustable air pressure switch, with graduated selector, to guarantee burner lock out in the case of insufficient combustible air
- Protection filter against radio interference
- IP 40 electric protection level.

Gas train

Fuel supply line in the Multibloc configuration, fitted with:

- Filter
- Pressure stabiliser
- Minimum gas pressure switch
- Safety valve
- Two stage working valve with ignition gas output regulator.

Approval:

- EN 676 standard.

Conforming to:

- 90/396/EEC (gas)
- 73/23/EEC (low voltage)
- 89/336/EEC (electromagnetic compatibility)
- 92/42/EEC (efficiency)
- 98/37/EEC (machines).

Standard equipment:

- Insulating gasket
- Screws and nuts for fixing the flange to the boiler
- 7-pin plug
- 4-pin plug
- Hinge
- Cable grommet
- Instruction handbook for installation, use and maintenance
- Spare parts catalogue.

Available accessories to be ordered separately:

- Extended head kit
- End cone with turbolator disk
- Town gas kit
- LPG kit
- Interface adapter kit
- 7-pin plug kit
- Ground fault interrupter kit
- Continuous ventilation kit for RMG control box
- Seal control kit.



RIELLO S.p.A. - Via Ing. Pilade Riello, 5 - 37048 San Pietro di Legnago (VR) Italy
Tel. ++39.0442630111 - Fax ++39.044221980

Internet: <http://www.rielloburners.com> - E-mail: info@rielloburners.com

Since the Company is constantly engaged in the production improvement, the aesthetic and dimensional features, the technical data, the equipment and the accessories can be changed.
This document contains confidential and proprietary information of RIELLO S.p.A.
Unless authorised, this information shall not be divulged, nor duplicated in whole or in part.

