

MODULATING LIGHT OIL BURNERS

▶ **PRESS P/G SERIES**

▶ P 140 P/G	415/830 ÷ 1660 kW
▶ P 200 P/G	590/1185 ÷ 2370 kW
▶ P 300 P/G	890/1780 ÷ 3560 kW
▶ P 450 P/G	1190/2670 ÷ 5340 kW

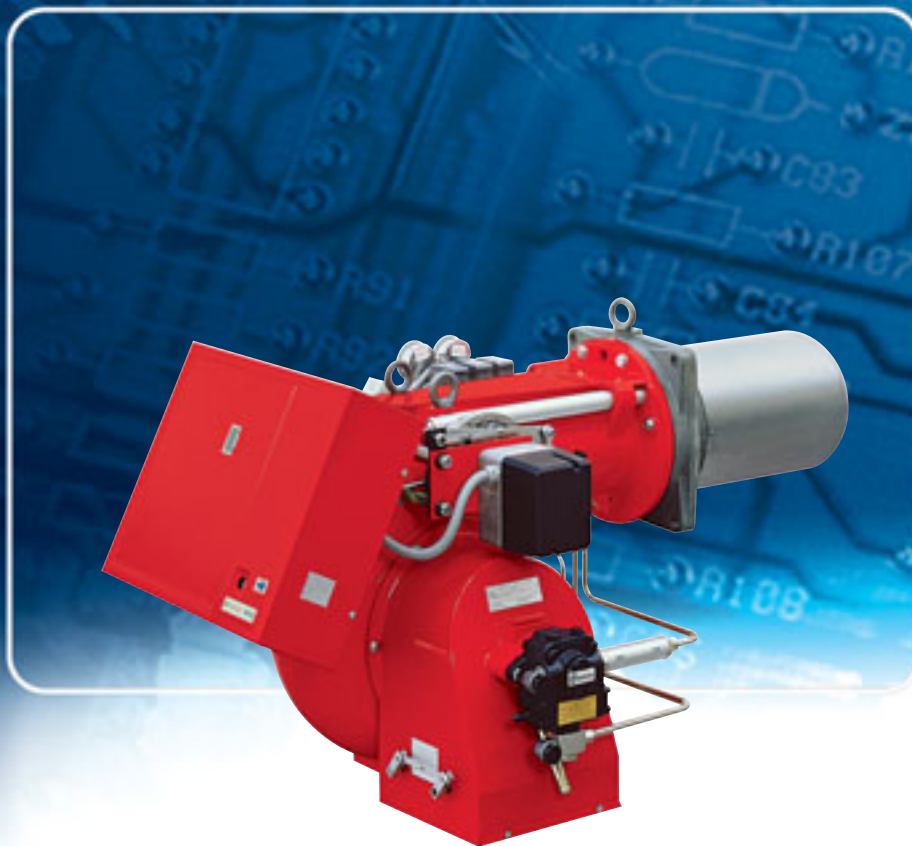

The PRESS P/G series of burners covers a firing range from 415 to 5340 kW. Setting can be "two stage progressive" or, alternatively, "modulating" with the installation of a PID logic regulator and respective probes, which guarantees a turn down ratio of 3:1. The versatility of this range makes the burner well suited for use on commercial or industrial applications where the load factor is subject to wide variations over a short period of time. Simplified maintenance is achieved by Riello designed slide bar system, which allows easy access to all of the essential components of the combustion head.



TECHNICAL DATA

Model		▼ P 140 P/G	▼ P 200 P/G	▼ P 300 P/G	▼ P 450 P/G
Burner operation mode		Modulating (with regulator and probes accessories) or Two-stage progressive			
Modulation ratio at max. output		3 ÷ 1			
Servomotor	type	SQM 10			
	run time	42			
Heat output	kW	415/830÷1660	590/1185÷2370	890/1780÷3560	1190/2670÷5340
	Mcal/h	357/714÷1428	507/1019÷2038	765/1531÷3062	1023/2296÷4592
	kg/h	35/70÷140	50/100÷200	75/150÷300	100/225÷450
Working temperature		°C min./max. 0/40			
Net calorific value	kWh/kg	11,86			
	kcal/kg	10200			
Viscosity		mm ² /s (cSt) 4 ÷ 6 (at 20°C)			
Pump	type	TA2	TA3	TA4	TA5
	delivery	330 (25 bar)	520 (25 bar)	700 (25 bar)	880 (25 bar)
Atomised pressure		bar 25			
Fuel temperature		max. °C 50			
Fuel pre-heater		NO			
Fan		type Centrifugal with forward curve blades			
Air temperature		max. °C 60			
Electrical supply		Ph/Hz/V 3N/50/400-230 (±10%) △ or 3/50/230 (±10%) △			
Auxiliary electrical supply		Ph/Hz/V 1/50/230 (±10%)			
Control box		type LAL 1.25			
Total electrical power		kW 4,5	5,5	10	18
Auxiliary electrical power		kW 1,5	1,5	2,5	3
Heaters electrical power		kW --			
Protection level		IP 40			
Pump motor electrical power		kW --			
Rated pump motor current		A --			
Pump motor start up current		A --			
Pump motor protection level		IP --			
Fan motor electrical power		kW 3	4	7,5	15
Rated fan motor current		A 8/13,5	9,5/16,4	17,5/30	29/50,2
Fan motor start up current		A 51/86	48/83	113/195	167/291
Fan motor protection level		IP 55			
Ignition transformer		type			
		V1 - V2 230 V - 2x6 kV			
		I1 - I2 2,3 A - 35 mA			
Operation		Intermittent (at least one stop every 24h)			
Sound pressure		dB (A) 86,5	85,5	89,5	90
Sound power		W --			
CO emission		mg/kWh < 35			
Grade of smoke indicator		N° Bacharach < 0,6			
CxHy emission		mg/kWh < 8 (after the first 20 seconds)			
NOx emission		mg/kWh < 200	< 200	< 200	< 220
Directive		89/336 - 73/23 - 92/42 - 98/37 EEC			89/336-73/23-98/37 EEC
Conforming to		EN 267			
Certification		DIN 5G459/2000	DIN 5G460/2000	DIN 5G461/2000	DIN 5G462/2000

Reference conditions:

Temperature: 20°C

Pressure: 1013,5 mbar

Altitude: 100 m a.s.l.

Noise measured at a distance of 1 meter.

Since the Company is constantly engaged in the production improvement, the aesthetic and dimensional features, the technical data, the equipment and the accessories can be changed.

This document contains confidential and proprietary information of RIELLO S.p.A. Unless authorised, this information shall not be divulged, nor duplicated in whole or in part.

FIRING RATES

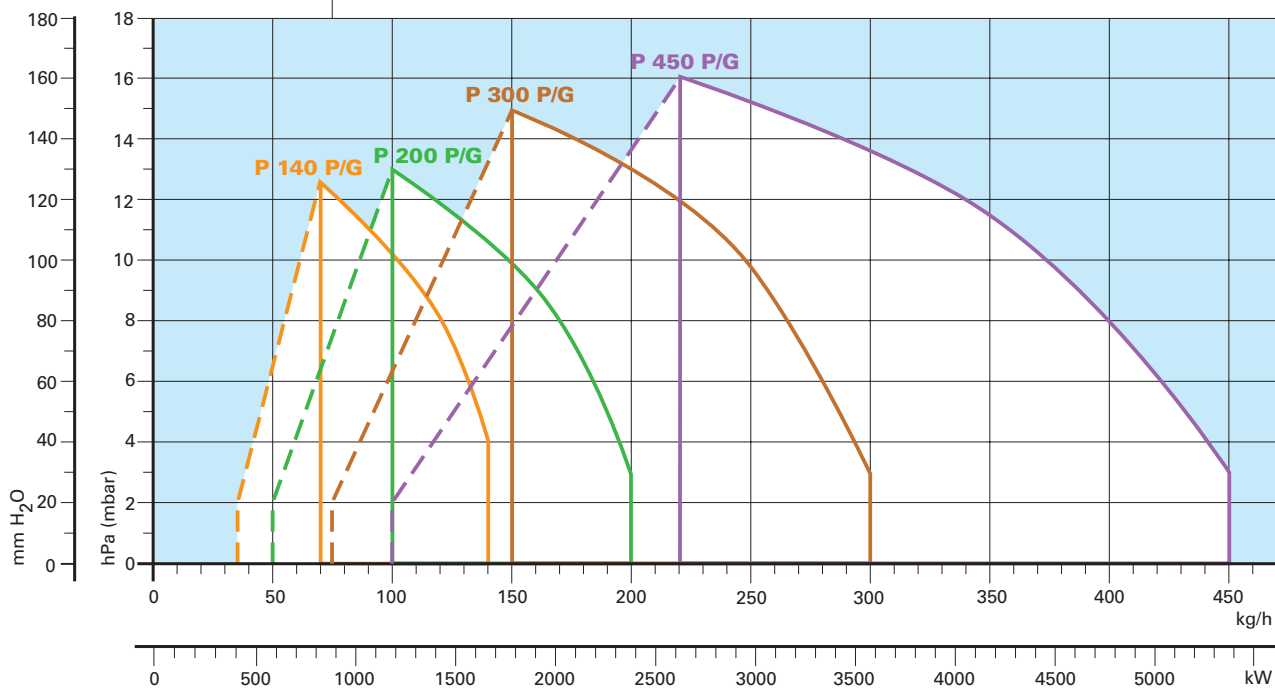

 Useful working field for choosing the burner

 Modulation range

Test conditions conforming to EN 267:

Temperature: 20°C
 Pressure: 1013.5 mbar
 Altitude: 100 m a.s.l.



FUEL SUPPLY

► HYDRAULIC CIRCUIT

Various hydraulic circuits are available, depending on fuel output asset according to local norms of steam generators.

The burners are fitted with two valves (a safety valve and an operation valve) and an oil filter along the oil line from the pump to the nozzle.

A pressure regulator on the return circuit from the nozzle allows to vary the quantity of fuel burnt.

A double safety valve on the return circuit avoids oil leakage from the nozzle when the burner is in stand-by and pre-purge phase.

The models are fitted with a maximum pressure switch on the oil return circuit.



Example of the hydraulic circuit on PRESS 200 P/G

EN 267 > 100 kg/h

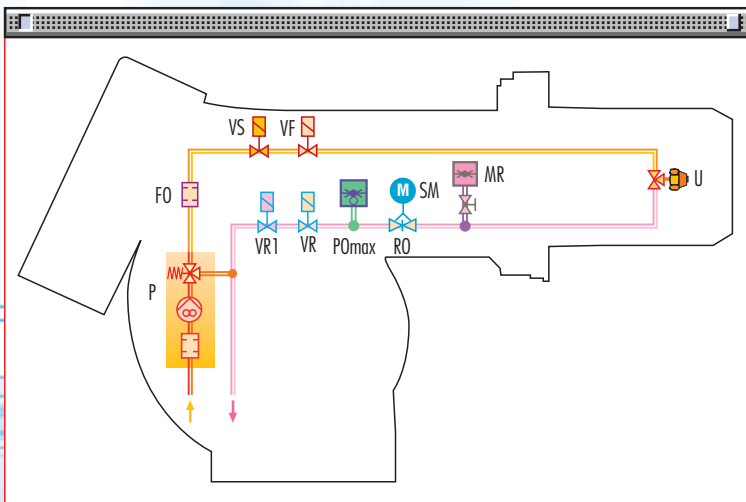

P	Pump with filter and pressure regulator on the output circuit
FO	Oil filter
VS	Safety valve on the output circuit
VF	Working valve on the output circuit
U	Nozzle
MR	Pressure gauge on the return circuit
SM	Servomotor
RO	Pressure regulator on the return circuit
PO max	Max. Oil pressure switch on the return circuit
VR	1st safety valve on the return circuit
VR1	2nd safety valve on the return circuit



SELECTING THE FUEL SUPPLY LINES

The fuel feed must be completed with the safety devices required by the local norms.

The table shows the choice of piping diameter for the various burners, depending on the difference in height between the burner and the tank and their distance.

MAXIMUM EQUIVALENT LENGTH FOR THE PIPING L[m]								
Model	▼ P 140 P/G		▼ P 200 P/G		▼ P 300 P/G		▼ P 450 P/G	
Diameter piping	Ø14mm	Ø16mm	Ø16mm	Ø18mm	Ø1/2"	Ø 3/4"	Ø 3/4"	Ø1"
+H, -H (m)	L _{max} (m)	L _{max} (m)	L _{max} (m)	L _{max} (m)	L _{max} (m)	L _{max} (m)	L _{max} (m)	L _{max} (m)
+2,0	50	70	40	60	25	85	55	130
+1,5	45	65	35	55	23	80	50	120
+1,0	40	60	30	50	20	70	45	110
+0,5	35	50	25	45	18	65	40	100
0	30	45	20	40	15	60	35	90
-0,5	25	40	18	35	12	50	30	80
-1,0	20	35	15	30	10	45	25	70
-1,5	15	30	13	25	8	35	20	60
-2,0	10	25	10	20	5	30	15	45
-3,0	5	15	5	10	3	15	10	25

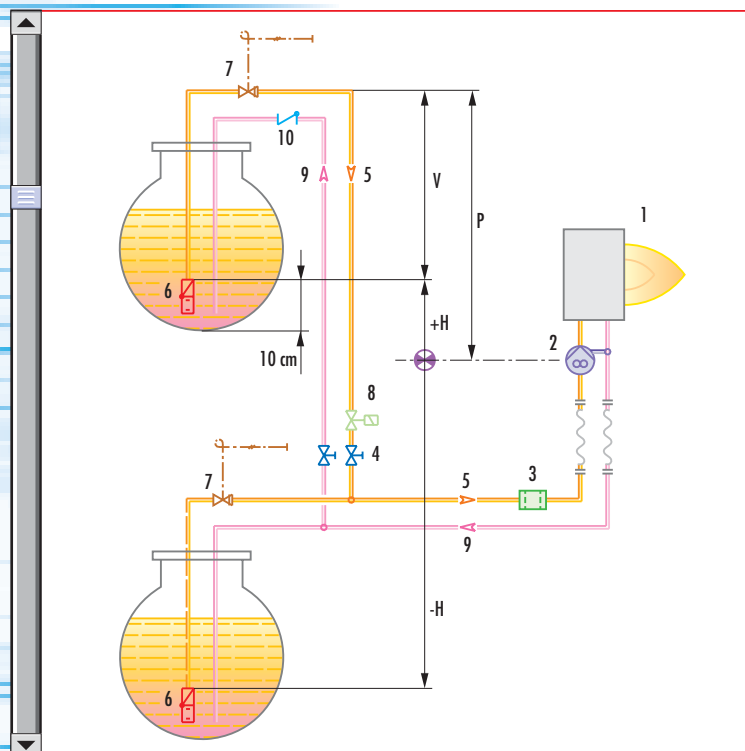

H	Difference in height pump-foot valve
Ø	Internal pipe diameter
P	Max. height 10 m
V	Height 4 m
1	Burner
2	Burner pump
3	Filter
4	Manual shut off valve
5	Suction pipework
6	Bottom valve
7	Remote controlled rapid manual shut off valve (compulsory in Italy)
8	Type approved shut off solenoid valve (compulsory in Italy)
9	Return pipework
10	Check valve

note With ring distribution oil systems, the feasible drawings and dimensioning are the responsibility of specialised engineering studios, who must check compatibility with the requirements and features of each single installation.



VENTILATION

The ventilation circuit is provided with a forward blades centrifugal fan, which guarantees high pressure levels at the required air deliveries and permits installation flexibility.

In spite of the remarkable output power and of the very high pressure performances, the structures of PRESS models are extremely compact. The use of sound proofing boxes help in reducing the noise level.

A variable profile cam connects fuel and air setting, ensuring fuel efficiency in all firing rates.

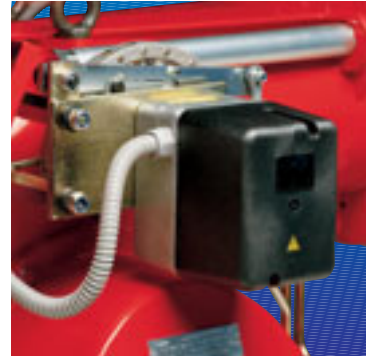

Example of servomotor for air/light oil setting



COMBUSTION HEAD

Two different lengths of the combustion head can be chosen for the various models of the PRESS P/G series of burners.

The choice depends on the thickness of the front panel and the type of the boiler.

Depending on the type of heat generator, it is necessary to check the correct head penetration into the combustion chamber.

These burners are equipped with a variable geometry combustion head. The chance to control air speed in combustion head is essential to gain the full advantage of a modulating burner. This function allows optimum combustion performance through the working field, ensuring peak combustion efficiency thus saving on fuel consumption.

The following diagram shows the flame dimensions in relation to the burner output. The length and diameter shown in the diagram below should be employed for a preliminary check: it is required a more careful investigation if combustion chamber dimensions are much different from the above reported values.



Example of a PRESS P/G burner combustion head

Flame dimensions

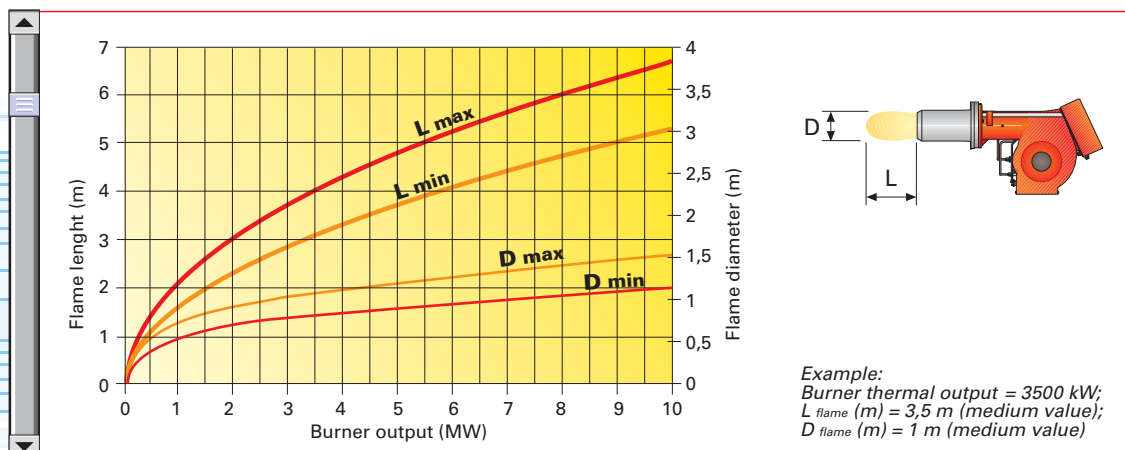

ADJUSTMENT



BURNER OPERATION MODE

The PRESS P/G series of burners can have "two-stage progressive" or "modulating" operation.

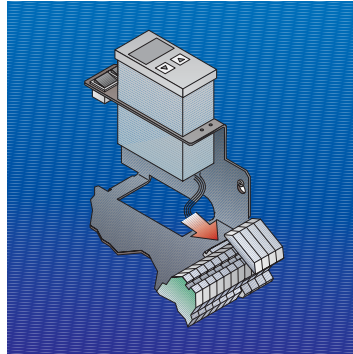

Example of a regulator

On "two-stage progressive" operation, the burner gradually adapts to the requested level, by varying between two pre-set levels (see picture A).

"Two-stage progressive" operation

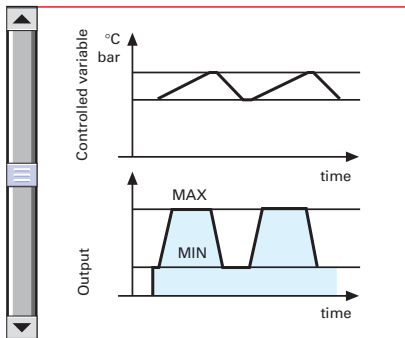

Picture A

On "modulating" operation, normally required in steam generators, in superheated boilers or diathermic oil burners, a specific regulator and probes are required. These are supplied as accessories that must be ordered separately. The burner can work for long periods at intermediate output levels (see picture B).

"Modulating" operation

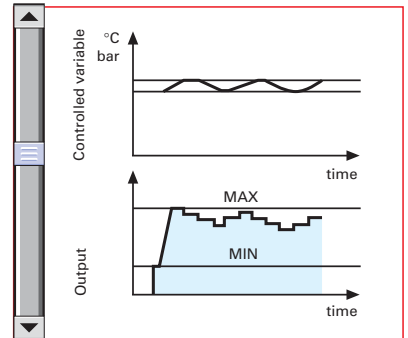

Picture B

START UP CYCLE

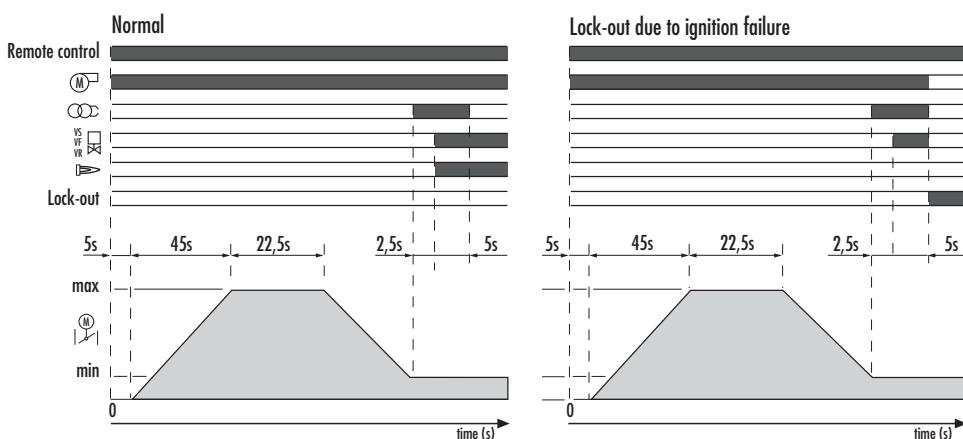

- 0" The burner begins the start-up cycle: the motor starts running.
- 5"-50" The servomotor opens the air damper at the maximum position.
- 50"-72,5" Pre-purge phase with air damper open.
- 72,5"-92,5" The servomotor takes the air damper to the ignition position.
- 92,5" Ignition transformer turns on.
- 95" Oil solenoid valves open and flame detection with P.E. cell is activated.
- 100" After a safety time of 7,5" the ignition transformer turns off if there is the flame, otherwise lock-out happens.



WIRING DIAGRAMS

Electrical connections must be made by qualified and skilled personnel, according to the local norms.

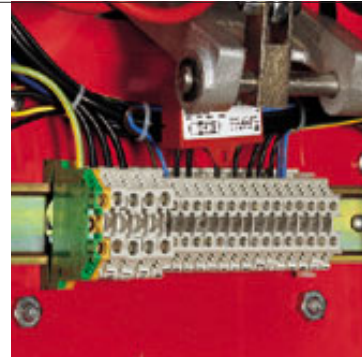

Example of the terminal board for electrical connections for P 140-200-300-450 P/G models

“TWO-STAGE PROGRESSIVE” OPERATION

Direct start-up version P 140-200-300 P/G

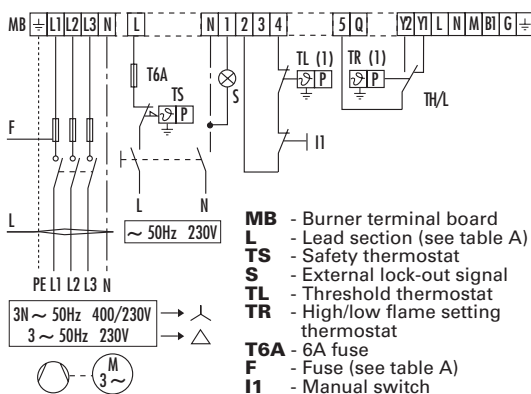

Star delta start-up version P 300-450 P/G

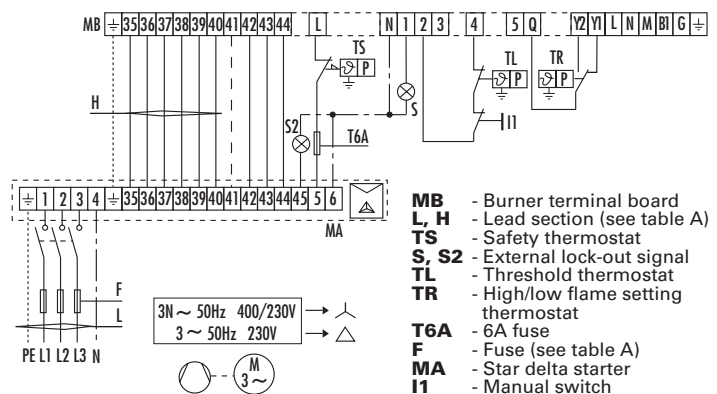

“MODULATING” OPERATION - temperature probe

Direct start-up version P 140-200-300 P/G

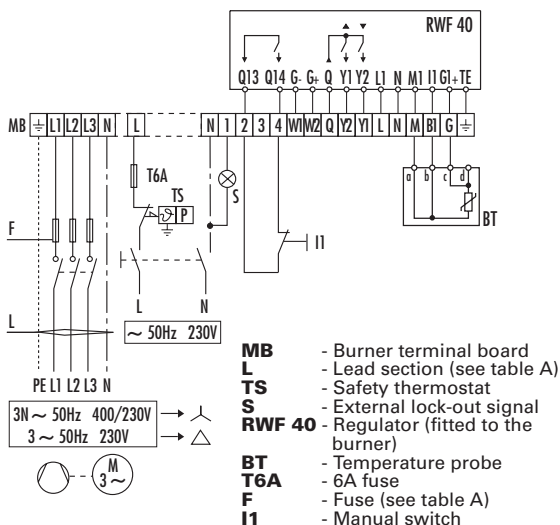

Star delta start-up version P 300-450 P/G

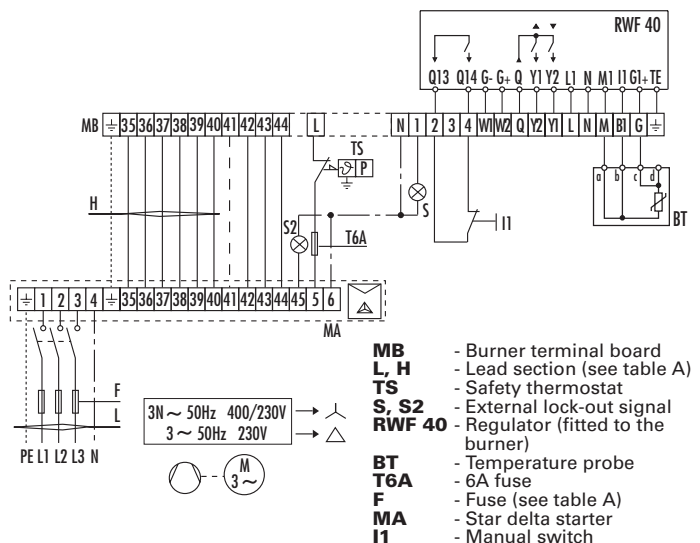

“MODULATING” OPERATION - pressure probe

Direct start-up version P 140-200-300 P/G

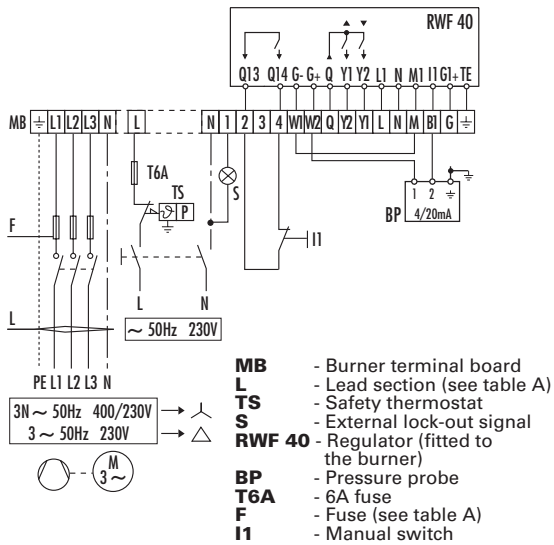

Star delta start-up version P 300-450 P/G

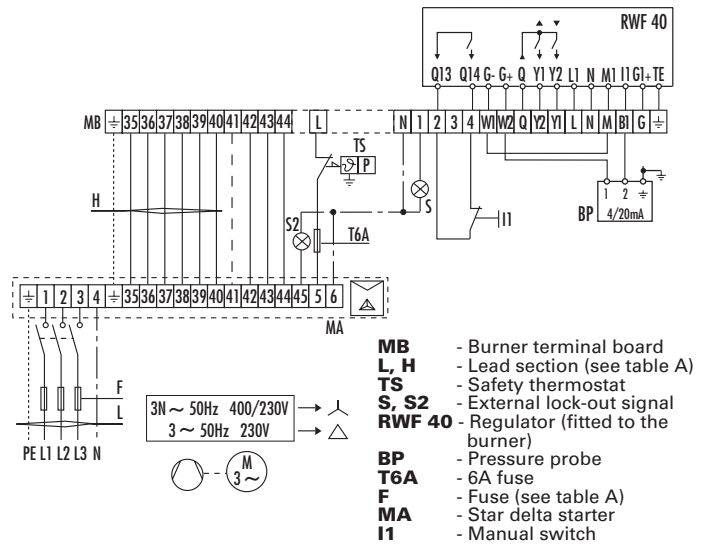

The following table shows the supply lead sections and the type of fuse to be used.

Model	Direct						Star delta			
	▼ P 140 P/G		▼ P 200 P/G		▼ P 300 P/G		▼ P 300 P/G		▼ P 450 P/G	
F A	230V	400V	230V	400V	230V	400V	230V	400V	230V	400V
L mm ²	T25	T25	T35	T25	T63	T50	T50	T35	T63	T50
H mm ²	2,5	2,5	4	2,5	6	4	6	4	10	6

Table A

EMISSIONS

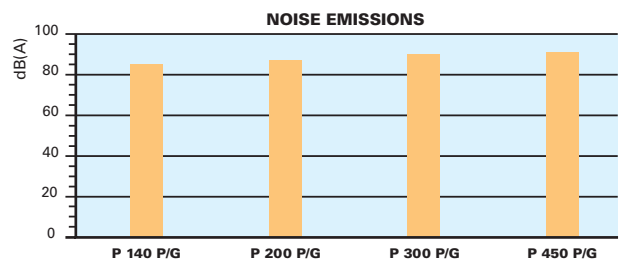
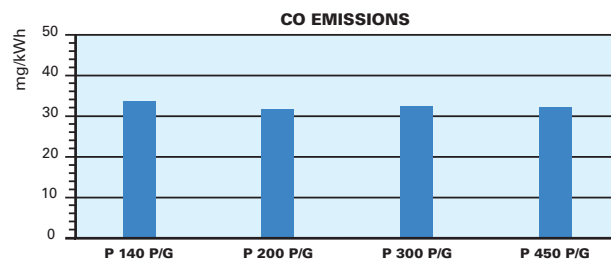
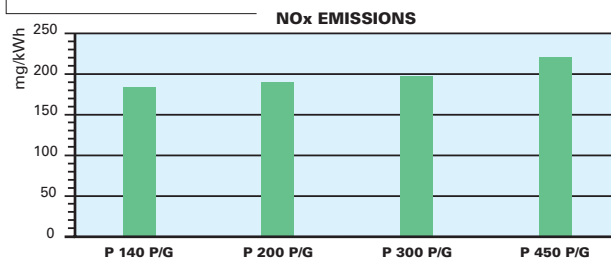

The emission data has been measured in the various models at maximum output, according to EN 267 standard.



OVERALL DIMENSIONS (mm)



BURNER

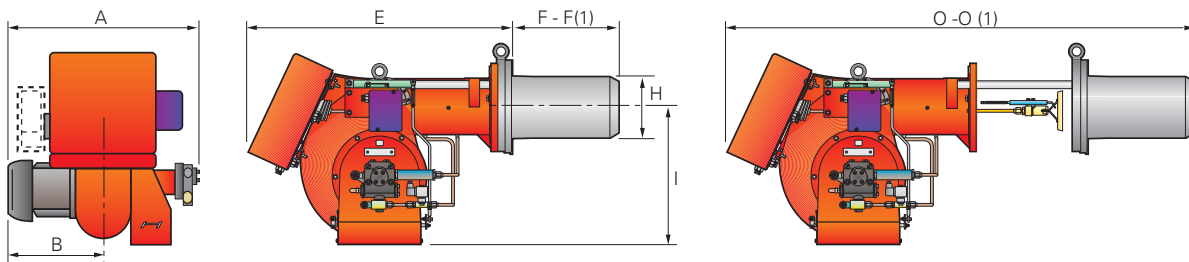

Model	A	B	E	F - F (1)	H	I	O - O (1)
▶ P 140 P/G	765	365	890	363 - 473	222	467	1250 - 1360
▶ P 200 P/G	796	396	890	391 - 501	250	467	1280 - 1390
▶ P 300 P/G	858	447	1000	444 - 574	295	496	1440 - 1570
▶ P 450 P/G	950	508	1070	476 - 606	336	525	1546 - 1676

(1) Length with extended combustion head

BURNER - BOILER MOUNTING FLANGE

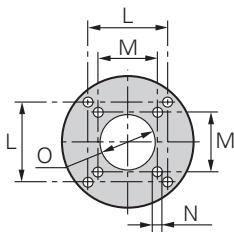

Model	L	M	N	O
▶ P 140 P/G	260	230	M14	225
▶ P 200 P/G	260	-	M16	255
▶ P 300 P/G	260	-	M18	300
▶ P 450 P/G	310	-	M20	340

PACKAGING

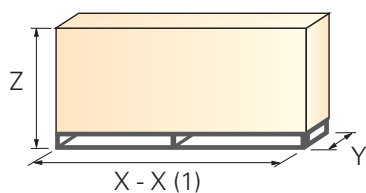

Model	X - X (1)	Y	Z	kg
▶ P 140 P/G	1500	930	905	130
▶ P 200 P/G	1500	930	905	220
▶ P 300 P/G	1780	1085	990	238
▶ P 450 P/G	1780	1085	990	300

(1) Length with extended combustion head



INSTALLATION DESCRIPTION



Installation, start-up and maintenance must be carried out by qualified and skilled personnel.
All operations must be performed in accordance with the technical handbook supplied with the burner.



BURNER SETTING

- ▶ All the burners have slide bars, for easier installation and maintenance.
- ▶ After removing the cover, the split pin and the pin, the nuts and the screws, dismantle the blast tube from the burner of approximately 100-120mm and fix it to the boiler.
- ▶ Adjust the combustion head.
- ▶ Refit the burner casing to the slide bars.
- ▶ Install the nozzle, choosing it on the basis of the maximum boiler output and following the diagrams included in the burner instruction handbook.
- ▶ Check the position of the electrodes.
- ▶ Close the burner, fasten the screws, the nuts, the split pin and the pin.

HYDRAULIC / ELECTRICAL CONNECTIONS AND START UP

- ▶ The burners are supplied for connection to two pipes fuel supply system.
- ▶ Connect the ends of the flexible pipes to the suction and return pipework using the supplied nipples.
- ▶ Make the electrical connections to the burner following the wiring diagrams included in the instruction handbook.
- ▶ Prime the pump by turning the motor (after checking rotation direction if it is a three phase motor).
- ▶ On start up, check:
 - Pressure pump and valve unit regulator (to max. and min.)
 - Combustion quality, in terms of unburned substances and excess air.



BURNER ACCESSORIES

Nozzles

The return nozzles must be ordered separately. The following table shows the features and codes on the basis of the maximum required output.

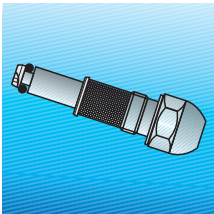

Nozzles			
Burner	Rated output kg/h (*)	Nozzles Bergonzo B5 45° without "SA" needle code	Nozzles Fluidics N2 45° without needle code
P 140 P/G	70	3009303	3045471
P 140 P/G	80	3009305	3045472
P 140 P/G	90	3009307	3045473
P 140 - 200 P/G	100	3009310	3045475
P 140 - 200 P/G	125	3009312	3045477
P 200 - 300 P/G	150	3009314	3045479
P 200 - 300 P/G	175	3009316	3045481
P 200 - 300 P/G	200	3009318	3045483
P 300 - 400 P/G	225	3009320	3045485
P 300 - 400 P/G	250	3009322	3045487
P 300 - 400 P/G	275	3009324	3045489
P 300 - 400 P/G	300	3009326	3045491
P 450 P/G	325	3009328	3045493
P 450 P/G	350	3009330	3045495
P 450 P/G	375	3009332	3045497
P 450 P/G	400	3009334	3045499
P 450 P/G	425	3009336	3045500
P 450 P/G	450	3009338	3045501

(*) Nozzle rated delivery is referred to atomised pressure

Spacer kit

If burner head penetration in the combustion chamber needs to be reduced, varying thickness spacers are available, as given in the following table.

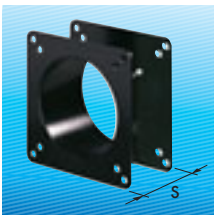

Spacer kit		
Burner	Spacer thickness S (mm)	Kit code
P 140 P/G	110	3000722
P 200 P/G	110	3000722
P 300 P/G	130	3000723
P 450 P/G	130	3000751

Sound proofing box

If noise emissions need to be reduced, sound proofing hoods are available, as given in the following table.



Sound proofing box			
Burner	Box type	Average noise reduction [dB(A)] (*)	Box code
P 140 P/G - P 200 P/G	C4/5	10	3010404
P 300 P/G - P 450 P/G	C7	10	3010376

(*) according to EN 15036-1 standard



Accessories for modulating operation

To obtain modulating operation, the PRESS P/G series of burners requires a regulator with three point outlet controls. The following table lists the accessories for modulating operation with their application range.



Burner	Regulator type	Regulator code
P 140 P/G - P 200 P/G P 300 P/G - P 450 P/G	RWF 40	3010211

The relative temperature or pressure probes fitted to the regulator must be chosen on the basis of the application.



Probe type	Range (°C) (bar)	Probe code
Temperature PT 100	-100 ÷ 500°C	3010110
Pressure 4 ÷ 20 mA	0 ÷ 2,5 bar	3010213
Pressure 4 ÷ 20 mA	0 ÷ 16 bar	3010214

Depending on the servomotor fitted to the burner, a three-pole potentiometer (1000 Ω) can be installed to check the position of the servomotor. The KITS available for the various burners are listed below.



Burner	Potentiometer kit code
P 140 P/G - P 200 P/G - P 300 P/G - P 450 P/G	3010021

Burner support

For easier maintenance, a mobile burner support has been designed, which means the burner can be dismantled without the need of forklift trucks.

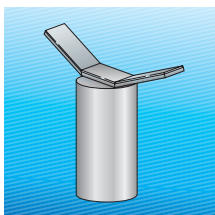

Burner support	
Burner	Support code
P 300 P/G - P 450 P/G	3000731



SPECIFICATION

A specific index guides your choice of burner from the various models available in the PRESS P/G series. Below there is a clear and detailed specification description of the product.

DESIGNATION OF SERIES

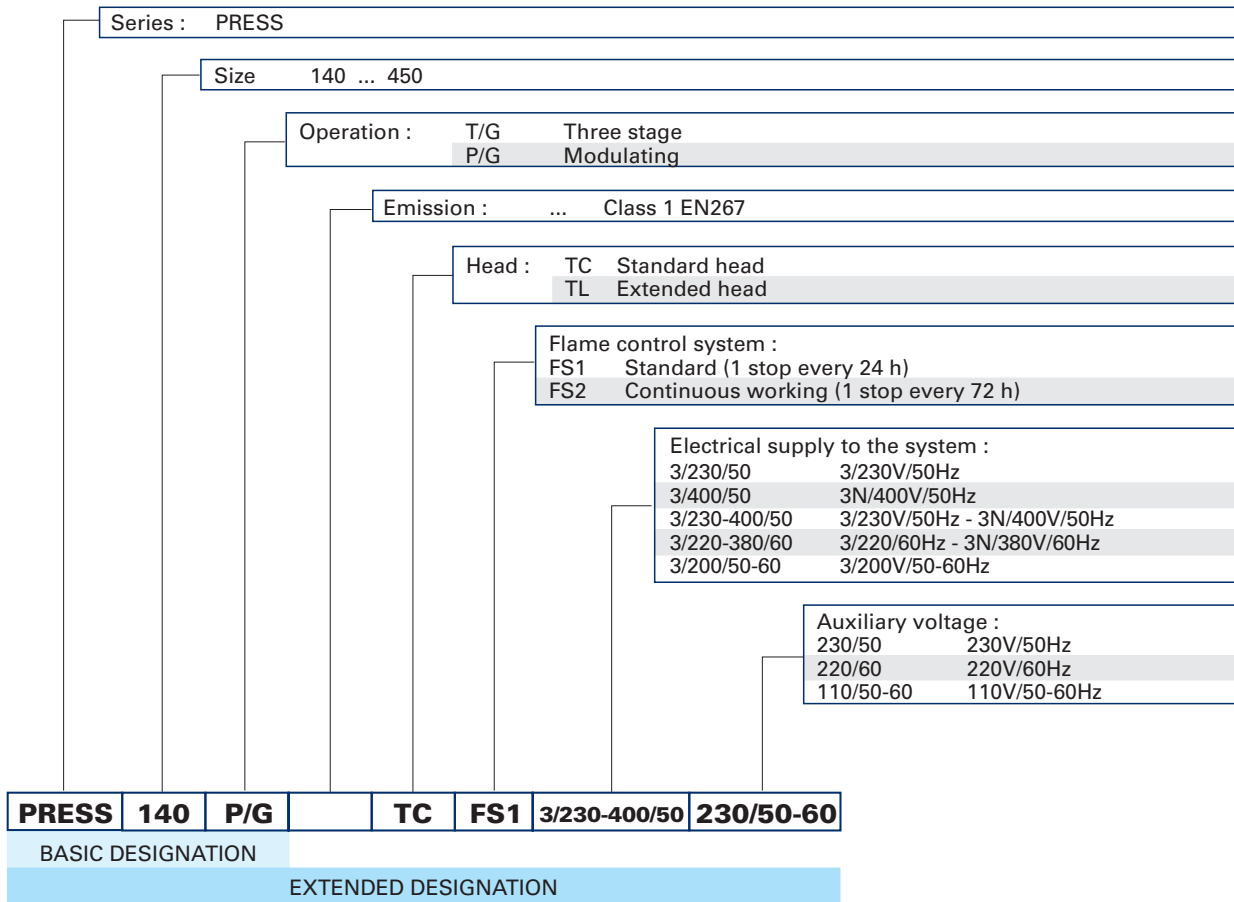

AVAILABLE BURNER MODELS

P 140	P/G	TC	3/230-400/50	230/50	P 300	P/G	TL	3/230/50	230/50
P 140	P/G	TL	3/230-400/50	230/50	P 300	P/G	TC	3/400/50	230/50
P 200	P/G	TC	3/230-400/50	230/50	P 300	P/G	TL	3/400/50	230/50
P 200	P/G	TL	3/230-400/50	230/50					
P 300	P/G	TC	3/230-400/50	230/50	P 450	P/G	TC	3/230/50	230/50
P 300	P/G	TL	3/230-400/50	230/50	P 450	P/G	TL	3/230/50	230/50
P 300	P/G	TC	3/230/50	230/50	P 450	P/G	TC	3/400/50	230/50
					P 450	P/G	TL	3/400/50	230/50

Other models are available on request.



▶ PRODUCT SPECIFICATION

Burner:

Monoblock forced draught oil burner with two-stage progressive or modulating operation, with a specific kit, fully automatic, made up of:

- Air suction circuit
- Fan with forward curved blades high performance pressure levels
- Air damper for air setting and automatic oil output regulator controlled by a servomotor with variable cam
- Starting motor at 2850rpm, three-phase 400V with neutral, 50Hz
- Combustion head, that can be set on the basis of the combustion output, fitted with:
 - Stainless steel end cone, resistant to corrosion and high temperatures
 - Ignition electrodes
 - Flame stability disk
- Gears pump for high pressure fuel supply, fitted with:
 - Filter
 - Pressure regulator
 - Connections for installing a pressure gauge and vacuumeter
 - Internal by-pass for single pipe installation
- Valve unit with a double oil safety valve on the output circuit and double safety valve on the return circuit
- Safety oil pressure switch for stop the burner in the case of problems on return circuit
- Photocell for flame detection
- Flame control panel, fitted with control function for the correct positioning of the servomotor and possibility of post-ventilation
- Flame inspection window
- Slide bars for easier installation and maintenance
- Protection filter against radio interference
- IP 40 electric protection level.

Conforming to:

- 89/336/EC directive (electromagnetic compatibility)
- 73/23/EEC directive (low voltage)
- 92/42/EEC directive (performance)
- 98/37/EEC directive (machinery)
- EN 267 (liquid fuel burners).

Standard equipment:

- 2 flexible pipes for connection to the oil supply network
- 2 nipples for the connection to the pump
- wiring looms fittings for electrical connections
- 4 screws for fixing the burner flange to the boiler
- 1 thermal screen
- instruction handbook for installation, use and maintenance
- spare parts catalogue
- 2 slide bar extensions (for the extended head models of P 300 P/G e P 450 P/G).

Available accessories to be ordered separately:

- return nozzles
- head length reduction kit (spacer)
- sound-proofing box
- RWF 40 output regulator
- pressure probe 0 ÷ 2,5 bar
- pressure probe 0 ÷ 16 bar
- temperature probe -100 ÷ 500 °C
- potentiometer kit for the servomotor
- burner support.



RIELLO S.p.A. - Via Ing. Pilade Riello, 5 - 37045 Legnago (VR) Italy
Tel. ++39.0442630111 - Fax ++39.044221980

Internet: <http://www.rielloburners.com> - E-mail: info@rielloburners.com

Since the Company is constantly engaged in the production improvement, the aesthetic and dimensional features, the technical data, the equipment and the accessories can be changed.
This document contains confidential and proprietary information of RIELLO S.p.A.
Unless authorised, this information shall not be divulged, nor duplicated in whole or in part.

